Preface

Thank you for purchasing our ultrasonic level transmitter. Please read this manual carefully before operating and using it correctly to avoid unnecessary losses caused by false operation.

Note

- Modification of this manual's contents will not be notified as a result of some factors, such as function upgrading.
- We try our best to guarantee that the manual content is accurate, if you find something wrong or incorrect, please contact us.
- This product is forbidden to use in explosion-proof occasions.

Version

U-SUP-MP-C/ULS-B-EN1

Safety Precautions

In order to use this product safely, be sure to follow the safety precautions described.

About this manual

- Please submit this manual to the operator for reading.
- Please read the operation manual carefully before applying the instrument. On the precondition of full understanding.
- This manual only describes the functions of the product. The company does not guarantee that the product will be suitable for a particular use by the user.

Precautions for protection, safety and modification of this product

- To ensure safety of this product and the systems it controls, Please read carefully the operation manual and understand the correct application methods before putting into operation, to avoid unnecessary losses due to operation mistakes. If the instrument is operated in other ways not described in the manual, the protections that the instrument give may be destroyed, and the failures and accidents incurred due to violation of precautions shall not be borne by our company.
- When installing lightning protection devices for this product and its control system, or designing and installing separate safety protection circuits for this product and its control system, it needs to be implemented by other devices.
- If you need to replace parts of the product, please use the model specifications specified by the company.
- This product is not intended for use in systems that are directly related to personal safety. Such as nuclear power equipment, equipment using radioactivity, railway systems, aviation equipment, marine equipment, aviation equipment and medical equipment. If applied, it is the responsibility of the user to use additional equipment or systems to ensure personal safety.
- Do not modify this product.

-
- The following safety signs are used in this manual:



Hazard, if not taken with appropriate precautions, will result in serious personal injury, product damage or major property damage.



Warning: Pay special attention to the important information linked to product or particular part in the operation manual.



- Confirm if the supply voltage is consistent with the rated voltage before operation.
- Don't use the instrument in a flammable and combustible or steam area.
- To prevent from electric shock, operation mistake, a good grounding protection must be made.
- Thunder prevention engineering facilities must be well managed: the shared grounding network shall be grounded at is-electric level, shielded, wires shall be located rationally, SPD surge protector shall be applied properly.
- Some inner parts may carry high voltage. Do not open the square panel in the front except our company personnel or maintenance personnel acknowledged by our company, to avoid electric shock.
- Cut off electric powers before making any checks, to avoid electric shock.
- Check the condition of the terminal screws regularly. If it is loose, please tighten it before use.
- It is not allowed to disassemble, process, modify or repair the product without authorization, otherwise it may cause abnormal operation, electric shock or fire accident.
- Wipe the product with a dry cotton cloth. Do not use alcohol, benzine or other organic solvents. Prevent all kinds of liquid from splashing on the product. If the product falls into the water, please cut off the power

immediately, otherwise there will be leakage, electric shock or even a fire accident.

- Please check the grounding protection status regularly. Do not operate if you think that the protection measures such as grounding protection and fuses are not perfect.
- Ventilation holes on the product housing must be kept clear to avoid malfunctions due to high temperatures, abnormal operation, shortened life and fire.
- Please strictly follow the instructions in this manual, otherwise the product's protective device may be damaged.



- Don't use the instrument if it is found damaged or deformed at opening of package.
- Prevent dust, wire end, iron fines or other objects from entering the instrument during installation, otherwise, it will cause abnormal movement or failure.
- During operation, to modify configuration, signal output, start up, stop, operation safety shall be fully considered. Operation mistakes may lead to failure and even destruction of the instrument and controlled equipment.
- Each part of the instrument has a certain lifetime, which must be maintained and repaired on a regular basis for long-time use.
- The product shall be scrapped as industrial wastes, to prevent environment pollution.
- When not using this product, be sure to turn off the power switch.
- If you find smoke from the product, smell odor, abnormal noise, etc., please turn off the power switch immediately and contact us in time.

Disclaimer

- The company does not make any guarantees for the terms outside the scope of this product warranty.
- This company is not responsible for damage to the instrument or loss of parts or unpredictable damage caused directly or indirectly by improper operation of the user.

No.	Name	Quantity	Note
1	Ultrasonic level transmitter	1	
2	Manual	1	
3	Certificate	1	
4	Mounting bracket	1	Compact type optional
5	Screwdrive	1	Remote type standard
6	Hanging piece of install	1	Remote type standard

Contents

Chapter 1 Introduction	1
1.1. Product Introduction	1
1.2. Operating principle	1
1.3. Liquid level measurement	2
1.4. Main Parameters	2
1.5. Without display selection	4
1.6. Product advantage	5
Chapter 2 Installation	7
2.1. Dimension	8
2.2. Wiring	10
2.3. Measuring liquid	13
2.4. Solid measurement	19
2.5. False echo blocking method	22
Chapter 3 Settings	26
3.1. Interface display	26
3.2. Error code	31
3.3. Button description	31
Chapter 4 Communication	32
4.1. Communication protocol	32
4.2. Function code	32
4.3. Error code	32
4.4. Query device address	32
4.5. broadcast instruction	32
4.6. Frame format	33
4.7. Example	34
4.8. Modbus register address correspondence table	35
Chapter 5 Troubleshooting	40
Chapter 6 Warranty & After-sales Service	42

Chapter 1 Introduction

1.1. Product Introduction

Ultrasonic level meter (for material and liquid level measurement) is a non-contact highly reliable and cost-effective material level measuring instrument which is easily installed and maintained. It can meet most of the material level measurement requirements without touch property rights developed by the company via years of hard work.

1.2. Operating principle

The ultrasonic wave is reflected when it meets the interface of liquid medium (solid medium) with different density, and the transmission time is measured to measure the liquid level / distance.

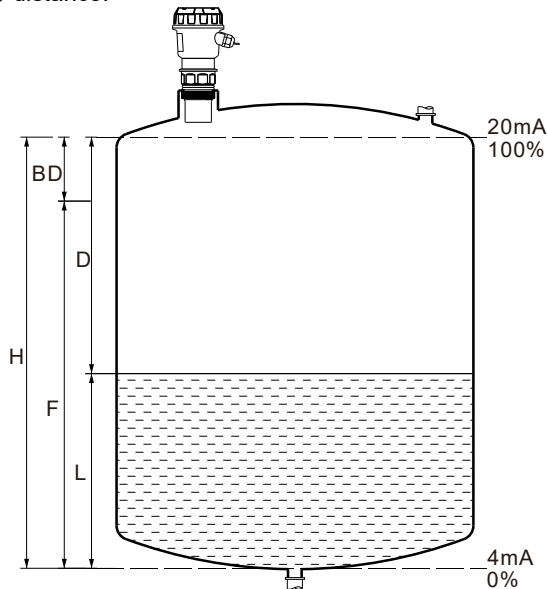

Figure 1 Measuring principle

BD: Blind distance H: Installation height F: Measuring range

D: The distance from probe emitting surface to material surface L: Level

1.3. Liquid level measurement

When measuring the liquid level, the user measures by setting the installation height and measuring mode in the menu. For specific settings, please refer to the 3.1 interface display, liquid level value = Installation height - distance value.

1.4. Main Parameters

Table 1 Main parameters of compact type

Measuring variable	Level / Distance
Power supply	(18~28)VDC
Measuring range	(0~5) m / (0~10) m / (0~15) m
Accuracy	±0.5% FS ±0.3%FS
Blind area	≤0.4m (5m、10m) ≤0.6m (15m)
Resolution	1mm or 0.1%FS (maximum)
Display	Monochrome LCD with resolution of 128 * 64
Current output	(4 ~ 20) mA , the output accuracy is 0.2%FS Output load is (U-18V)/0.02A (U:supply voltage,2-wire) Output load is (U-14V)/0.02A (U:supply voltage,4-wire)
Communication	RS485 (4-wire)
Relay output	2 groups (4-wire optional)
Working temperature	Instrument: (-20~+60)°C Probe: (-20~+80)°C
Ingress Protection	Instrument: IP65 Probe: IP68
Relative humidity	(10~85)%RH (no condensation)
Language	Chinese/English
Installation method	Threaded installation
Display method	With display (Optional without display. Refer to 1.5 for

	settings without display)
--	---------------------------

Table 2 Mainparameters of remote type

Measuring variable	Level / Distance
Power supply	(100~240)VAC,5W Max,50/60Hz; (18~28)VDC
Measuring range	(0~5) m / (0~10) m / (0~15) m
Accuracy	±0.5% FS ±0.3%FS
Blind area	≤0.3m (5m) ≤0.35m (10m) ≤0.5m (15m)
Resolution	1mm or 0.1%FS (maximum)
Display	Monochrome LCD with resolution of 128 * 64
Current output	Isolated (4 ~ 20)mA , the maximum load is 500Ω, and the output accuracy is 0.2%FS
Communication	Isolated RS485 Modbus-RTU Communication Protocol
Relay output	2 groups (i.e. AC 250V/ 8A or DC 30V/ 5A) optional, 4 groups optional
Working temperature	Instrument: (-20~+60)°C Probe: (-20~+80)°C
Ingress Protection	Instrument: IP65 Probe: IP68
Probe cable	10m (standard configuration), 30m available
Relative humidity	(10~85)%RH (no condensation)
Language	Chinese/English
Installation method	Wall mounted installation

1.5. Without display selection

The selection of the compact ultrasonic level gauge without display cannot use the button to set the installation height, so the factory default of the ultrasonic level gauge without display is the distance mode. For example, to measure the liquid level, users can convert the liquid level according to the installation height, or support the acquisition equipment such as digital display. To convert distance to liquid level in the acquisition device, refer to 1.5.1 conversion formula.

1.5.1. Conversion formula

The following formula needs to be matched with collection equipment to be used.

Ultrasonic liquid level measuring range (0~X) m, measuring distance L m, installation height H m.

Liquid level $Y = (H-L)$ m.

The default distance transmission output is (0~X) m, corresponding to the current output (4~20) mA.

When $H \leq X$, the range of liquid level is (0~H) m.

When $H > X$, the range of liquid level is ((H~X) ~ H) m.

The current output (4~20) mA corresponds to the liquid level (H~(H - X) m.

The current output corresponding to liquid level I is $((16 \cdot H - 16 \cdot Y) / X + 4)$ mA.

1.5.2. Example

An example is given according to 1.5.1 formula.

When $H \leq X$.

The measuring range of ultrasonic liquid level is (0~10) m, the measuring distance is 2m, and the installation height is 8m.

The range of liquid level is (0~ 8) m.

Liquid level = installation height-measuring distance = 6m.

The current output is (4 ~ 20) mA, corresponding to the liquid level (8 ~ -2) m, and the liquid level is 6m output 7.2mA.

When $H > X$.

The measuring range of ultrasonic liquid level is (0-10) m, the measuring distance is 8m and the installation height is 12m.

The range of liquid level is (2~12) m.

Liquid level = installation height-measuring distance = 4m.

The current output is (4~20) mA, corresponding to the liquid level (12 ~ 2) m, and the liquid level is 4m output 16.8mA.

1.6.Product advantage

- Coach has rich menu interaction between Chinese and English, and the operation is simple.
- The touch button is used in the remote type, which can improve the quality of human-computer interaction.
- The technology of fault self-diagnosis can realize real-time fault self-diagnosis, and the user's self-test is very convenient.
- Selection of algorithms for various working conditions to ensure measurement accuracy
- The measurement resolution is high and the resolution is less than 3mm.
- The measured values respond quickly, and the fastest response time is 2 seconds.
- Automatic temperature compensation, through temperature compensation of sound speed, thus improving the accuracy of measurement.
- Echo curve display is helpful for field debugging and fault detection.

Chapter 2 Installation

Please read this section when installing this product.

Avoid the following location during installation

- Location where sunlight directly hits and near hot appliances
- Location where the ambient temperature exceeds 60°C during work
- Location where the ambient humidity exceeds 85% at work
- Near the electromagnetic generation source
- Location with strong mechanical vibration
- Location with high temperature changes and easy condensation
- The installation position of the probe should ensure that the distance value of the measured medium is larger than the blind area of the instrument, otherwise it is easy to cause the problem of abnormal measured value.

Notes for remote type

The connection between the split probe and the host can not be set in the same slot as the alternating current of 220VAC or 380VAC, and the distance between the power lines of 220VAC and 380VAC is at least 50cm or 100cm. At the same time, it is impossible to avoid being installed in the same slot or pipe as the alternating current, so that the cable between the sensor and the host can be shielded through a metal tube. This setting allows it to be placed inside the metal tube, and where the alternating current is close, the metal tube itself should be reliably grounded.

2.1. Dimension

2.1.1. Compact type dimension

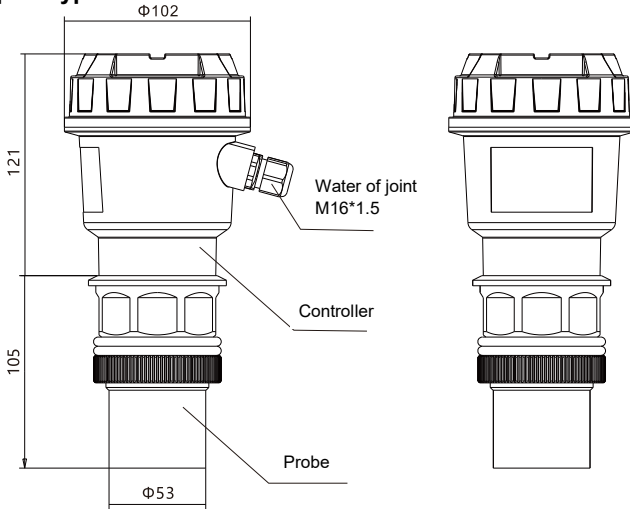

Figure 2 M60×2 or G2 Thread Sensor (5m/10m)

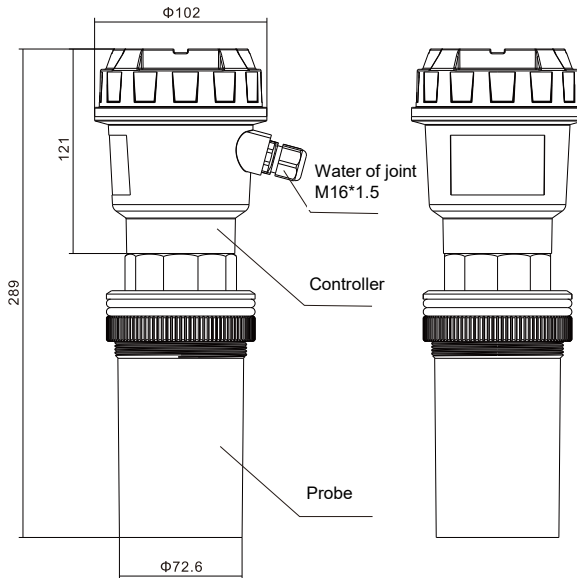

Figure 3 M78×2 Thread Sensor (15m)

2.1.2.Remote type dimension

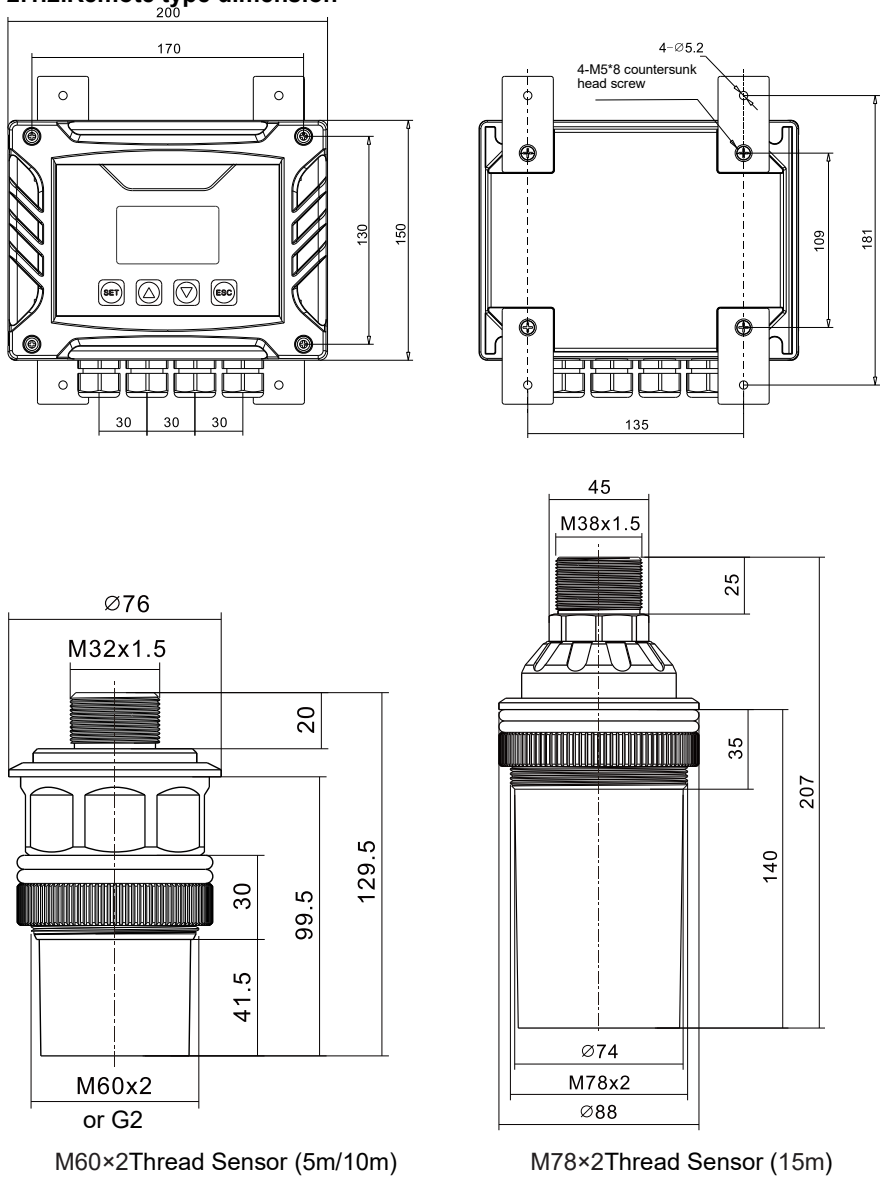

Figure 4 Remote type dimension

2.2. Wiring

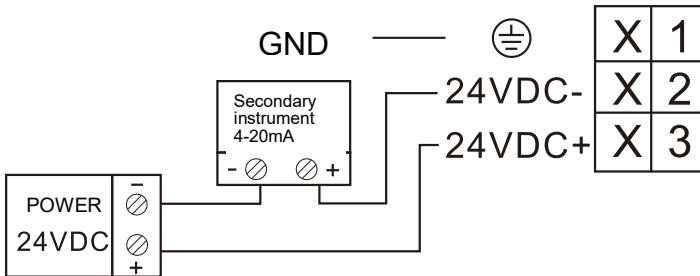
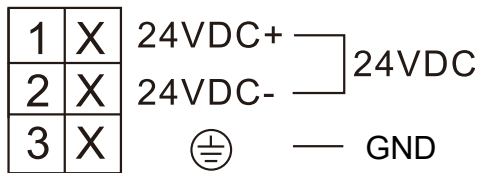
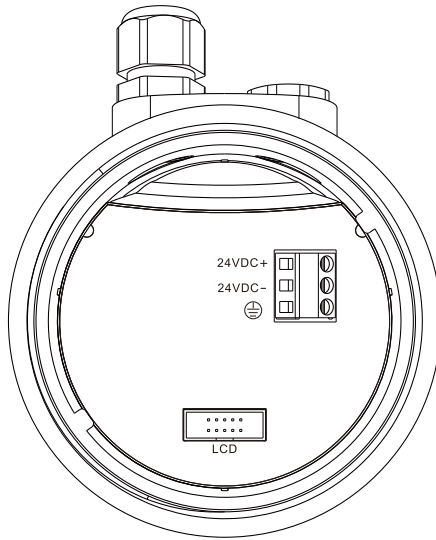

Figure 5 2-wire compact type dimension

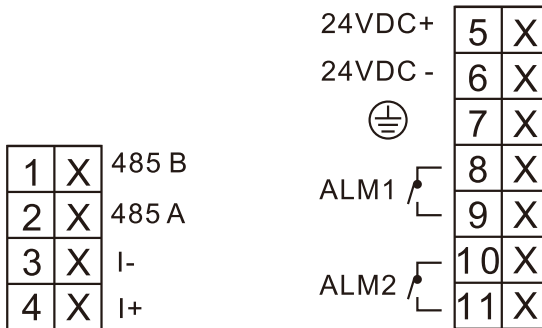
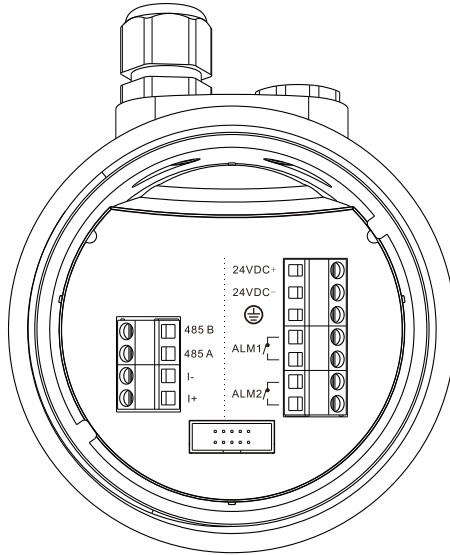

Figure 6 4-wire compact type dimension

1/2:485 B/A:RS485 output B/A

3/4:I-/I+:(4~20)mA output -/+

5/6:24VDC +/-:24V 3-wire/4-wire power supply +/-

7:GND

8/9:ALM1:Alarm 1

10/11:ALM2:Alarm 1

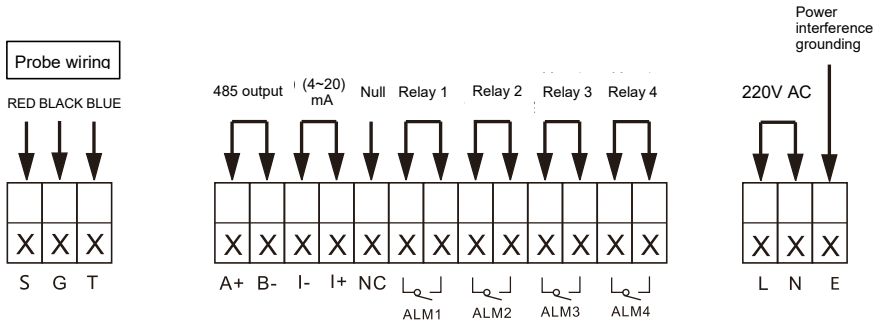

Figure 7 Remote type dimension (220V power supply)

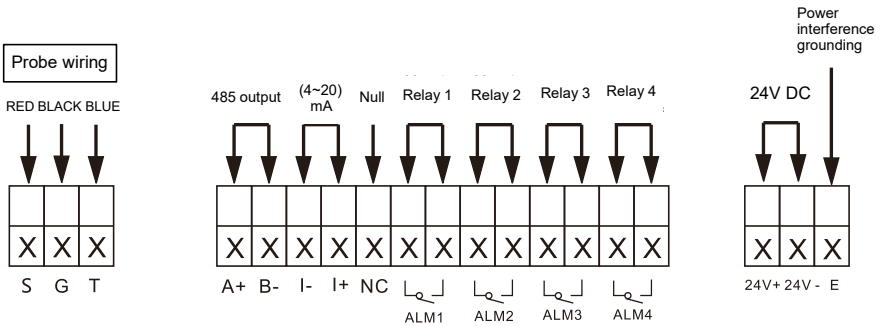

Figure 8 Remote type dimension (24V power supply)

2.3.Measuring liquid

(1) Flat-top tank

Flat-top tanks generally have a very short nozzle. The reference surface of the nozzle is the bottom surface of the flange. When the length of the nozzle is $\leq 60\text{mm}$, the inner diameter of the nozzle is $\geq 100\text{mm}$, and the inner wall of the nozzle is flat without burrs or protrusions, the probe is installed after installation. The emission surface can be measured 30mm below the bottom surface of the flange.

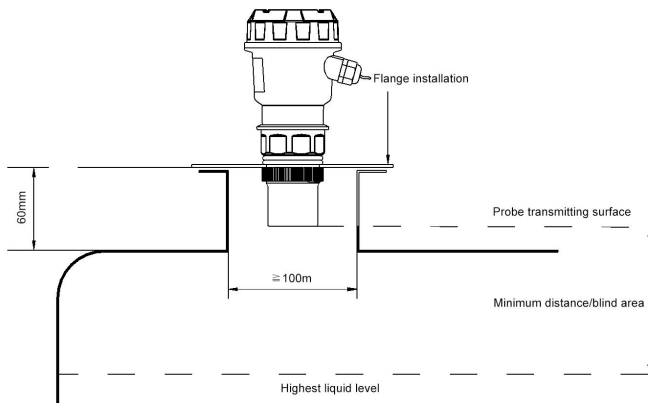

Figure 9 Flange installation - installed in a short nozzle

The most ideal installation is to directly install the instrument on a flat-top container. Without using a nozzle, the circular opening on the container can be sufficient to fix the flange or universal joint for installation. The emitting surface of the probe is below the reference plane.

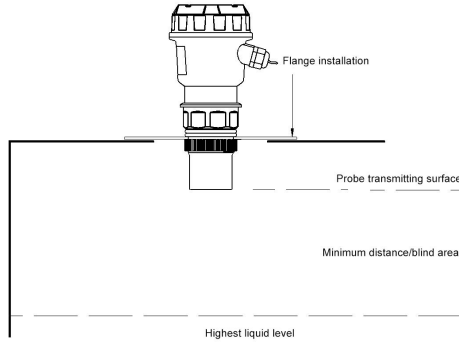

Figure 10 Flange Type (Locking Flange)-Installed on Flat Top Tank

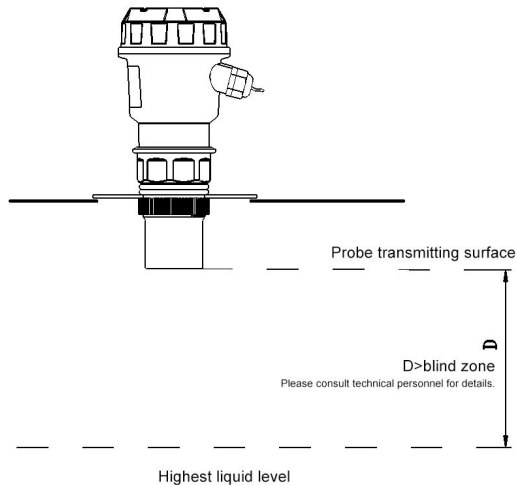

Figure 11 Flange type is installed on flat head tank without nozzle

It is installed on the same threaded nozzle as the probe. In this case, the internal diameter of the nozzle is almost the same as the external thread of the probe. The emitting surface of the probe must extend more than 10mm beyond the nozzle and cannot be retracted into the nozzle.

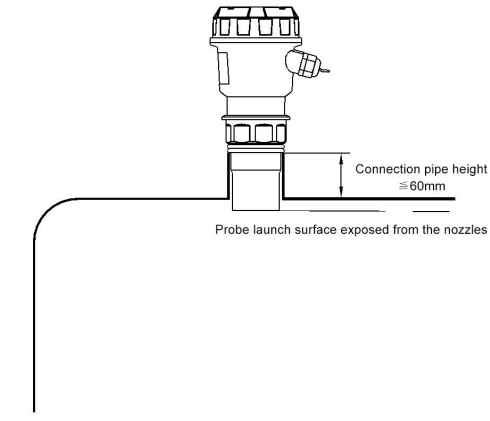

Figure 12 The probe is mounted on the threaded nozzle.

(2) Arched tank top

For arched tanks, it is better to install the instrument not at the center of the tank top, but at $1/2$ or $2/3$ of the radius of the tank top (on the premise of satisfying a certain distance from the tank wall). For ultrasonic pulses, the dome-shaped tank top is like a convex lens. If the probe is mounted on the focal point of the convex lens, it will receive all false echoes. Therefore, it should be avoided as far as possible to install the sensor probe in the center of the dome-shaped tank top.

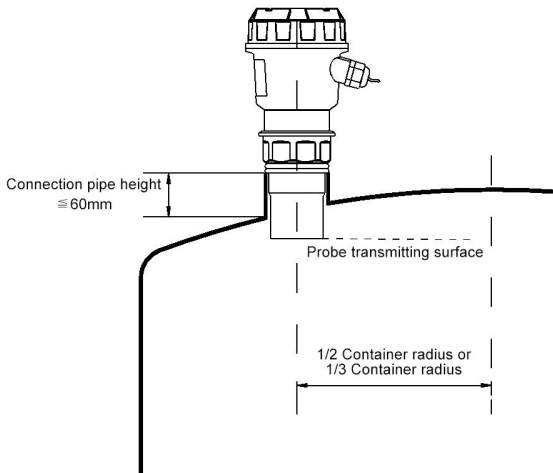

Figure 13 Installed on threaded nipple-dome roof

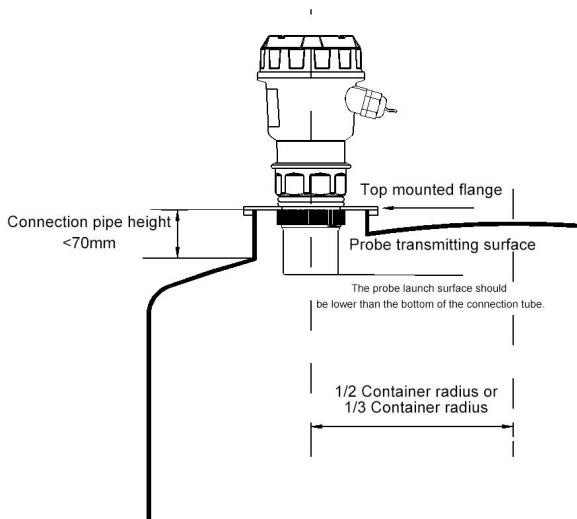

Figure 14 Installed on flange-dome roof

If the length of the nozzle exceeds the thread of the probe, the measurement will be affected. It is recommended to apply for a customized extended probe to make the shooting surface of the probe extend out of the bottom of the nozzle, and the proportional relationship between the inner diameter of the nozzle and the length of the nozzle

Table 3

NO	Nozzle length	Minimum size of nozzle Inner diameter	Remarks
1	150mm	100mm	The inner wall of the nozzle is free of burrs and bulges, vertical from top to bottom, and the welding seam must be polished. The joint between the nozzle and the tank top shall be polished at an oblique angle of 45° from the inside to the outside of the nozzle.
2	200mm	150mm	
3	250mm	180mm	
4	300mm	220mm	
5	400mm	280mm	

(3) Open tank

For open tank, the bracket can be used for installation. Attention should be paid to the bearing capacity of the bracket to keep a certain distance between the sensor and the container wall. If the inner wall of the open tank or silo is flat up and down, no hanging occurs, and no other objects are on the inner wall, then the distance between the sensor and the container wall is shown in the following table:

Table 4

Maximum range	Minimum distance from wall	Maximum range	Minimum distance from wall
5M	0.5M	10M	1.0M
15M	1.5M	20M	2.5M

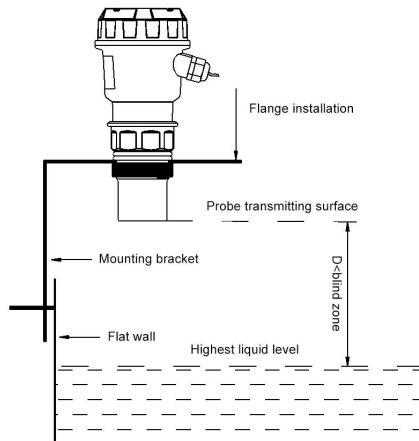

Figure 15 On the open tank - the top is mounted on one side bracket
 Since the open tank has no focusing effect, the sensor can be installed in the middle of the container.

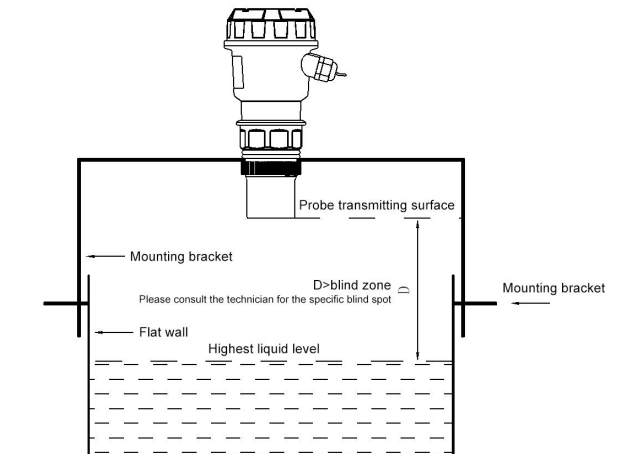

Figure 16 On Open tank -Top Center Bracket Installation

(4) Drainage wells and ordinary wells

Drainage wells are usually narrow in shaft and wellhead, and the borehole wall is uneven, which makes ultrasonic measurement very difficult. This problem can be solved by installing a section of nozzle or installing the entire measuring sleeve. It should be noted that after the sensor is placed in the nozzle, the blind area will increase by about 50% ~ 100%, and the factor of increasing the blind area should be taken into account.

Therefore, if the original probe blind area is 0.50 meters when the nozzle is used, the blind area will increase to 0.75m~1.00m meters when the nozzle is placed inside the nozzle.

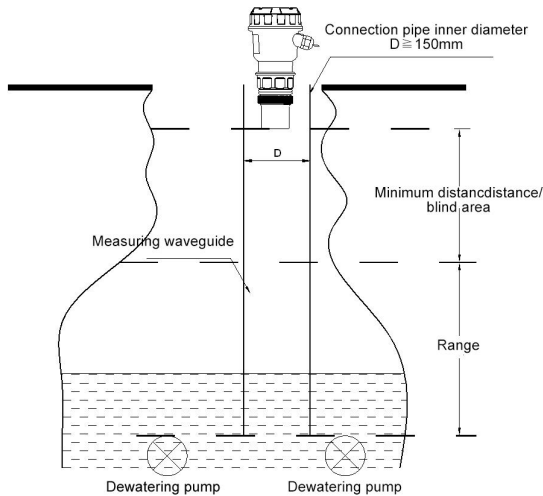

Figure 17 nozzle used for measuring drainage well.

Ordinary water wells (including water source wells and deep water wells) generally have small diameters, and measuring sleeves can be installed to achieve the best measuring effect. The inner wall of measuring sleeves must be smooth (e.g. PVC or PE waste water pipes) and the inner diameter $\geq 150\text{mm}$ (within the measuring range of 4 meters). If the takeover exceeds 4 meters, the manufacturer shall be consulted. As long as the measuring nozzle can be kept clean, free of adhered media and free of seams inside, measurement can be made. The measuring sleeve shall be soaked in the medium all the time so as to ensure accurate measurement in the measuring nozzle.

2.4. Solid measurement

(1) Flange mounting

Like measuring liquid medium, the instrument can be installed on the butt flange of the container nozzle. Since the reflection surface of the solid is different from that of the liquid and is not a plane, this problem should be considered during installation. The emitting surface of the probe should be perpendicular to the surface of the solid to be measured, and the probe should be able to protrude from the nozzle.

In the field of measuring solid, if the probe is retracted into the nozzle, the measured data will jump or "wave drop" will occur in most cases.

In order to solve this problem, a universal flange can be selected, so that as long as the flange is rotated, it is easy to align the emitting surface of the probe with the solid reflecting surface to be measured.

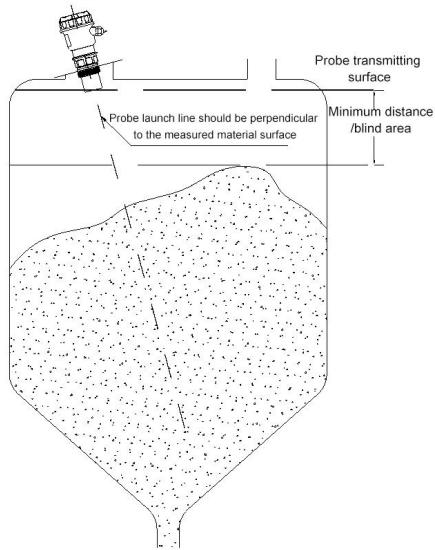

Figure 18 Installed on container flange

(2) Threaded pipe installation

When installing with a threaded nipple, the probe must be exposed more than 2cm from the bottom of the nipple.

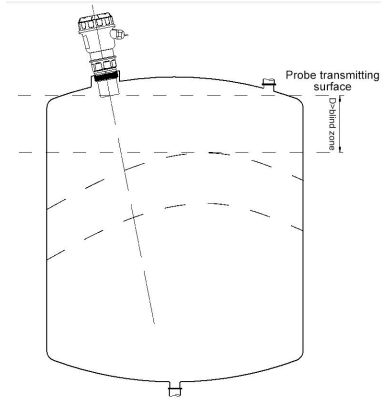

Figure 19 Threaded pipe installation

(3) Installation of frame type

Gantry frame type installation can be adopted in open tank, and the axis of the nozzle must be aligned with the container outlet or perpendicular to the medium surface.

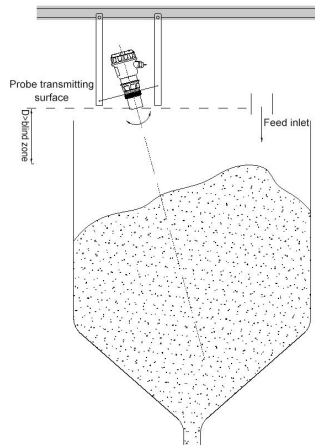

Figure 20 Installation of frame type

During the installation of the open-air material pile, the large open-air material pile needs to be measured by a plurality of meters, the meters can be fixed on the lifting frame, and the sensor probe should be aligned with the surface of the medium.

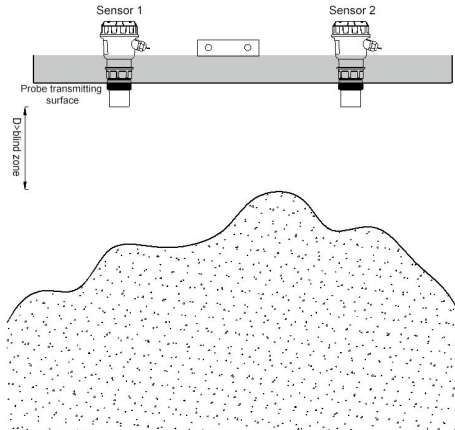

Figure 21 Measurement of open-air material pile-installation on lifting frame

2.5. False echo blocking method

(1) Device and Installation in Container

When installing the sensor, care must be taken not to have other devices or materials blocking the ultrasonic beam. Protrusions on the inner plane of the container or obstacles like steps will have a great impact on the measurement. A refraction plate can be blocked at the protrusion to refract the false echo, thus ensuring the accuracy of the measurement.

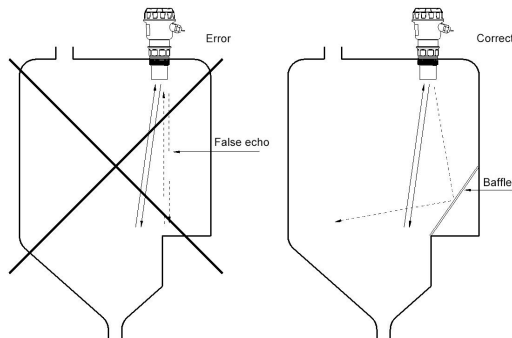

Figure 22 Step-like obstacles in the container-need to add inclined horizontal plates to refract false echoes away

If the upper surface of any object on the lower part of the container is flat, it must be blocked by a refraction plate with a certain angle for water inlet of various media.

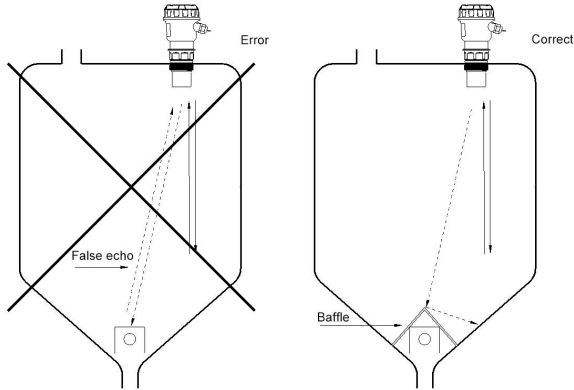

Figure 23 A projection with a flat top at the bottom of the container-a refracting plate should be added.

Devices inside the container, such as pipes and brackets, will affect the measurement. In the design of measuring points, attention must be paid to the fact that there cannot be other devices within the diffusion range of ultrasonic signals.

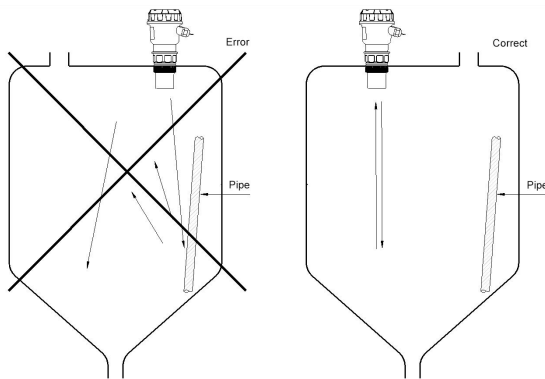

Figure 24 Obstacles in containers-pipes

The container wall has adherents-a certain distance from the adherents

(2) Common installation errors

① Bubble

If the bubbles on the surface of the medium are large and the bubble layer is thick, measurement errors will be caused and even reflected ultrasonic waves will not be received. Please take measures to prevent bubble generation, or install the sensor in the bypass pipe for measurement. Other measuring instruments can also be used, such as radar level gauge or magnetostrictive level gauge.

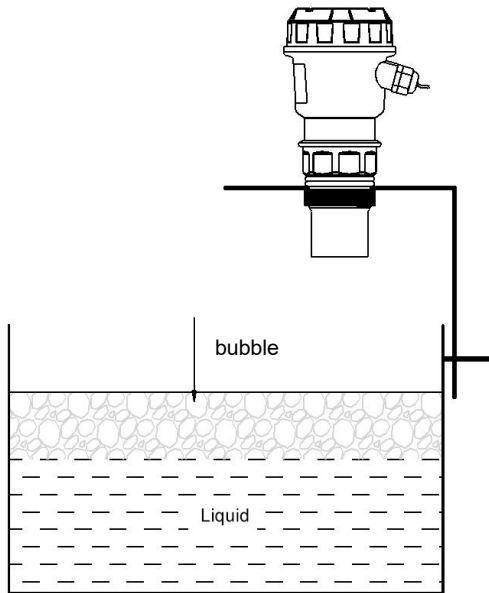

Figure 25 Location with bubbles

② The sensor installation direction is wrong

If the sensor is not installed on the surface of the medium, the measurement signal will be weakened. In order to ensure the best measurement effect, please align the axis of the sensor with the surface of the medium, that is, perpendicular to the surface of the measured interface.

③ Installed in a position with large temperature change

In locations with large temperature changes, such as intense solar radiation, measurement errors will be caused. This error will increase by 2-4% over the original measurement accuracy. Please install a sun visor to solve this problem.

④ The minimum distance to the medium is less than the blind area

If the distance between the probe and the highest position of the medium is smaller than the blind area of the meter, the measured values are all wrong.

⑤ The sensor is too close to the container wall

If the sensor is installed too close to the container wall, it will produce strong false echo. The uneven inner surface of the container wall, the adhered medium, rivets, screws, reinforcing ribs and welds on the inner wall of the container will all cause strong false echoes, which will be loaded on the effective echo signals. Therefore, please note: keep the distance between the sensor and the container wall according to the maximum distance to be measured. For more severe measurement conditions, the distance between the sensor and the container wall should continue to be enlarged until no false echo appears.

⑥ The sensor probe needs to be installed on metal plates such as flanges, if there is no gasket or the installation is too tight.

It is easy to cause ultrasonic wave, which is generated by the mechanical expansion of the sensor probe. If the installation is too tight or the gasket-less probe is easy to resonate with the mounting plate, resulting in abnormal measurement, make sure that the sensor probe only needs to be fixed with the force of the hand, and add the gasket.

Chapter 3 Settings

3.1.Interface display

3.1.1.Monitoring Interface

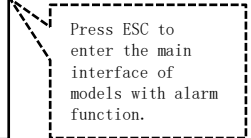
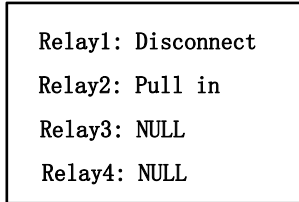
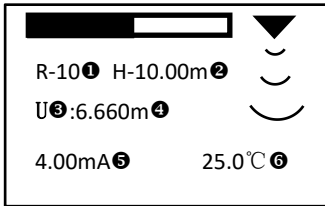

Icon	Note
	Bar chart (scale chart of measuring distance and measuring range)
	Measurement status (left: normal measurement, right: entering the blind area or out of range)
¹	Range (R-5: range 5m ; R-10: range 10m R-15 : range 15m)
²	Mount height or error code (installation height is displayed in normal state and error code is displayed in error state)
³	Measurement mode (level / distance)
⁴	Unit of measurement(m/cm/mm)
⁵	Current value
⁶	Temperature value

3.1.2.Menu Interface

Main Menu (The dashed box is the default display range of the interface. You can turn the page to view the following options)

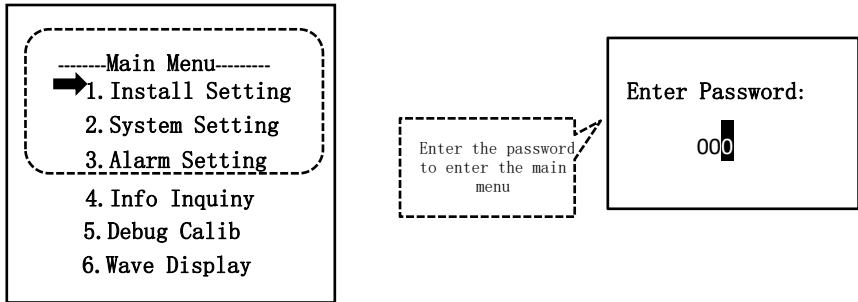

Secondary menu (The dashed box is the display range)

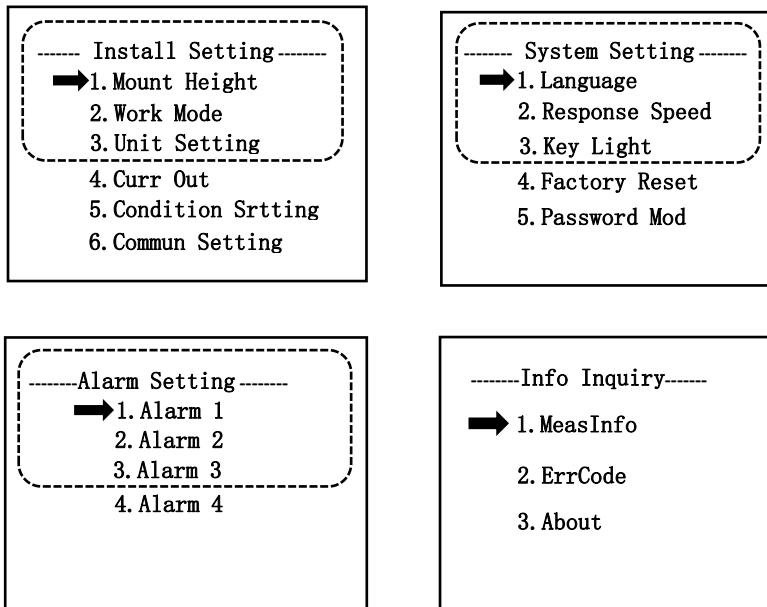

Three level menu

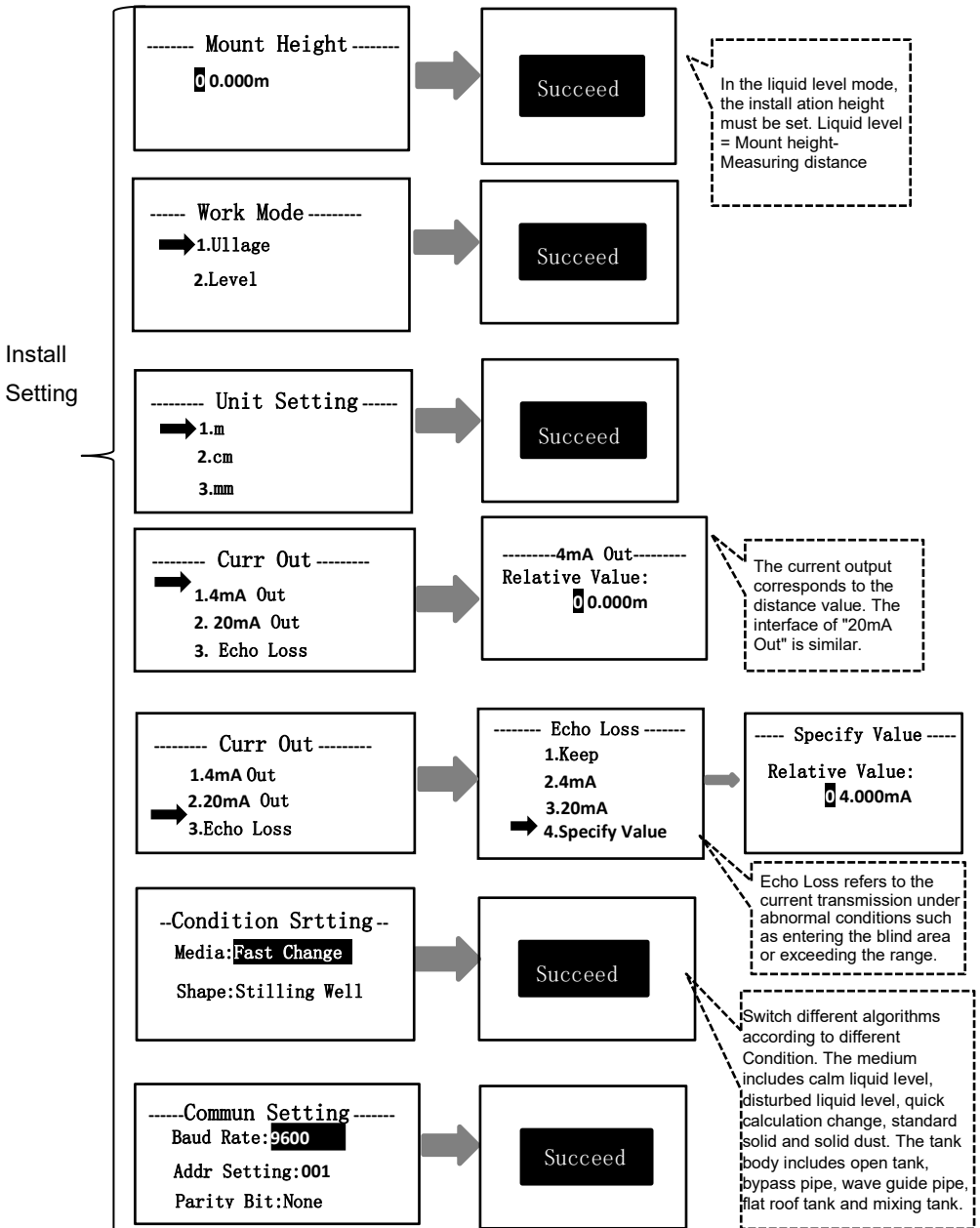

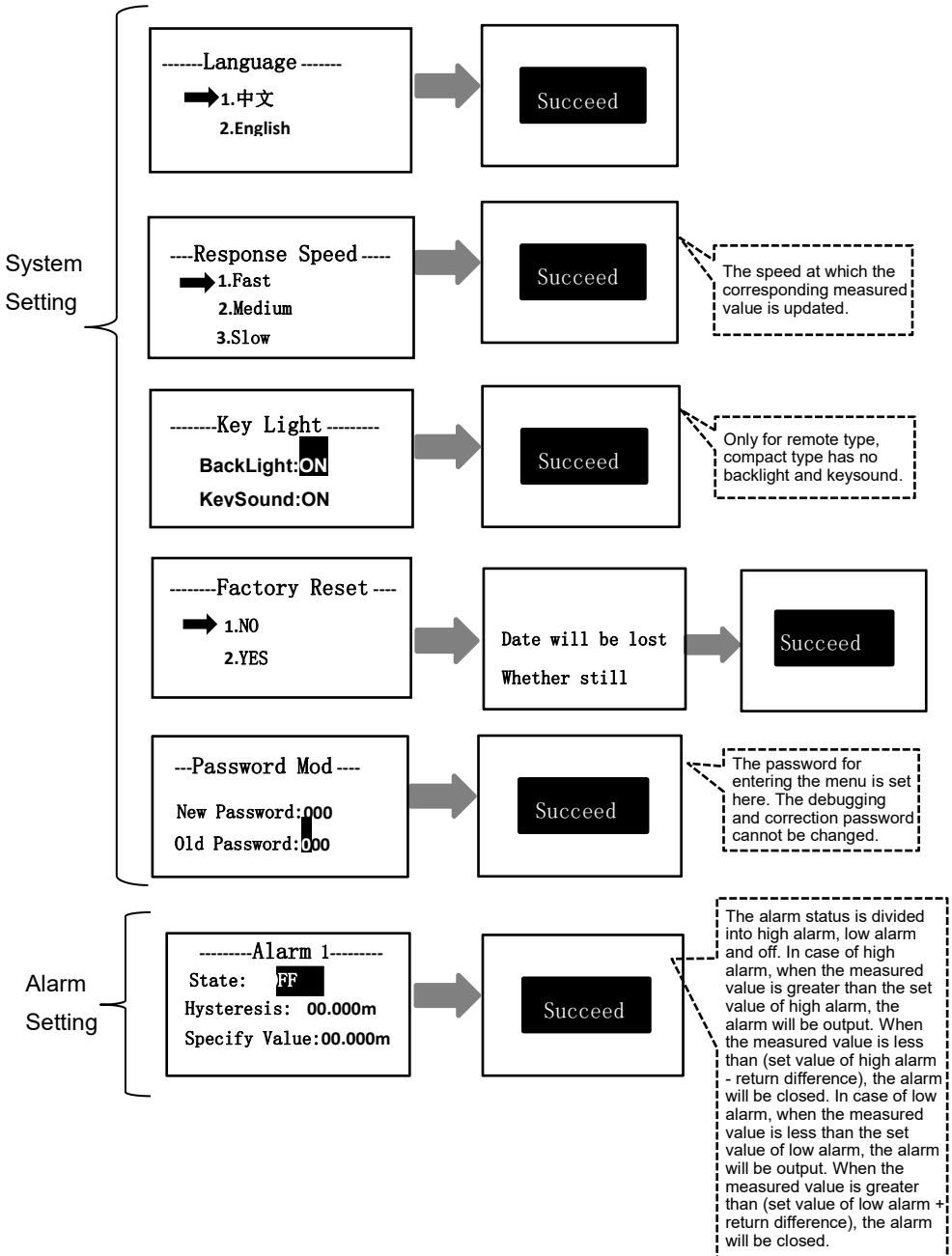

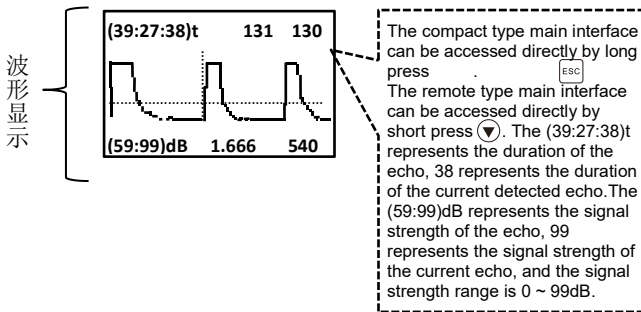
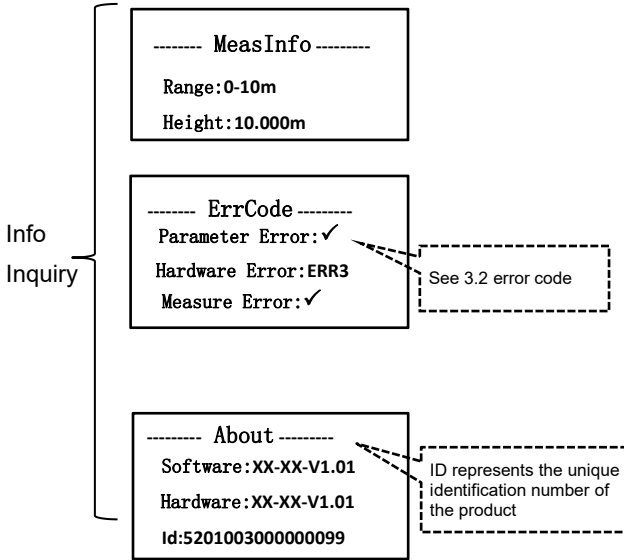





3.2.Error code

Error code	Explanation
ERR1	Storage unit exception, failed to write data.
ERR2	The temperature sensor is abnormal or not connected.
ERR3	Ultrasonic probe abnormal or not connected
ERR4	The product is not calibrated.
ERR5	Configuration data exception.
ERR6	Configuration data exception.
ERR7	Type selection data exception.
ERR8	Abnormal time of ultrasonic wave.
ERR9	Abnormal connection of circuit board.
ERR10	Serial port data sending exception.

3.3.Button description

Identification	Button name	Function description
	Setting key	(1) Press the button in the main interface for a short time to enter the menu interface. (2) In menu mode, enter the subordinate menu and confirm the parameter modification.
	Move up key	(1) In menu mode, enter the previous menu. (2) Shift the cursor when you modify the parameters.
	Move down key	(1) Menu mode, select the next menu . (2) When you modify the parameters, the cursor parameters cycle from 0 to 9. (3) The main interface, press the key for a short time to enter the waveform display interface.
	Exit key	(1) Menu mode, return to the previous menu interface (2) The main interface, press the button for a short time to enter the alarm monitoring interface

Chapter 4 Communication

4.1.Communication protocol

Name	Description
Communication interface	RS485
Transmission mode	ModBus RTU
Port settings	9600,N,8,1(default) see 4.2
Device address	0x01 (default)

4.2.Function code

Function code	Description
0x03	Read register data, error return code 0x83.
0x06	Write a single register, error return code 0x86.
0x10	Write multiple registers, error return code 0x90.

4.3.Error code

Error code	Description
0x01	The instruction is invalid or the current instruction is not available, this feature is not supported.
0x02	The contents of this address cannot be written to data.
0x03	The current input data is invalid and exceeds the input range.

4.4.Query device address

The device address is unknown, you can use address 0x00 to send 03 instructions to query the device address, which is only valid in single-machine mode.

4.5.broadcast instruction

When the address of the host sending device is 0xff, it is a broadcast instruction, and the slave does not respond to the broadcast instruction.

4.6.Frame format

4.6.1.Read register data

Inquiry:

Name	Device address	Function code	Initial address	Number of registers	CRC
Data	Addr	0x03	M	N	CRC16
Length bytes	1	1	2	2	2

Response:

Name	Device address	Function code	Return byte	Return data	CRC
Data	Addr	0x03	N*2	Data	CRC16
Length bytes	1	1	1	N*2	2

4.6.2.Write a single register

Inquiry:

Name	Device address	Function code	Initial address	Data value	CRC
Data	Addr	0x06	M	Data	CRC16
Length bytes	1	1	2	2	2

Response:

Name	Device address	Function code	Initial address	Data value	CRC
Data	Addr	0x06	M	Data	CRC16
Length bytes	1	1	2	2	2

4.6.3.Write multiple registers

Inquiry:

Name	Function code	Initial address	Number of data	Number of bytes	Data value	CRC
Data	0x10	M	N	N*2	Data	CRC16
Length bytes	1	2	2	1	N*2	2

Response:

Name	Device address	Function code	Initial address	Number of data	CRC
Data	Addr	0x10	M	Data	CRC16
Length bytes	1	1	2	2	2

4.7.Example

4.7.1.Read data

Initial address is 0x0000, and the number of read registers is 2.

Device address	Function code	Initial address	Number of registers	CRC
0x01	0x03	0x0000	0x0002	0xC40B

Data response: The read register data is 0x0001,0x0002

Device address	Function code	Return byte	Return data	CRC
0x01	0x03	0x04	0x0001,0x0002	0x2A32

If the current instruction is not available,return an error response.

Device address	Function code	Error code	CRC
0x01	0x83	0x01	0x80F0

4.7.2.Write data

Register address 0x0001,write data 0x0002.

Device address	Function code	Initial address	Data value	CRC
0x01	0x06	0x0001	0x0002	0x59CB

Data response:

Device address	Function code	Initial address	Data value	CRC
0x01	0x06	0x0001	0x0002	0x59CB

If the current register is not writable,return an error response.

Device address	Function code	Error code	CRC
0x01	0x86	0x02	0xC3A1

4.7.3.Continuous write data

From the register address 0x0001, write two register values continuously, 0x0002,0x0003.

Device address	Function code	Initial address	Number of data	Number of bytes	Data value	CRC
0x01	0x10	0x0001	0x0002	0x04	0x0002,0x0003	0xD3A2

Data response:

Device address	Function code	Initial address	Number of data	CRC
0x01	0x10	0x0001	0x0002	0x1008

If the written data is invalid, return an error response.

Device address	Function code	Error code	CRC
0x01	0x90	0x03	0x0C01

4.8.Modbus register address correspondence table

Registers with * support continuous writing of data.

Name	Register	Function code	Data type	Access type	Description
RS485 slave address	*0x1100	0x03/0x06	short	W/R	1~254
RS485 baud rate	*0x1101	0x03/0x06	short	W/R	1= 2400, 2= 9600 (default) , 3=14400 , 4=19200 , 5= 38400
Serial port configuration	*0x1102	0x03/0x06	short	W/R	1= N81(default) , 2 = N82 3 = E81, 4 = O81 N:No parity E:Even parity O:Odd parity 8:Data bit 8 digits 1:Stop bit 1 digit 2:Stop bit 2 digits

Name	Register	Function code	Data type	Access type	Description
Data version and device type	0x2000	0x03	short	R	High byte:Data version Low byte:Device type Data version:0x01 Device type:0x52
Distance instantaneous value	0x2001	0x03	short	R	Range:0 ~ 25000 Decimal places:3 Unit:m Read indication:2345 Corresponding measured value:2.345m
Level instantaneous value	0x2002	0x03	short	R	Same as distance instantaneous value
Temperature instantaneous value	0x2003	0x03	short	R	Range:-100~1100 Decimal places:2 Unit:°C Read indication: 2073 Corresponding temperature:20.73°C
Current output instantaneous value	0x2004	0x03	short	R	Range:4000~20000 Decimal places:3 Unit:mA Read indication:19000 Corresponding current :19.000mA
Error code	0x2005	0x03	long	R	See 4.3 error code
Measurement status	0x2007	0x03	short	R	0:Normal 1:The wave is lost

Range	0x2008	0x03	short	R	The reading indication is 5, and the corresponding range is 0 ~ 5m
Mount Height	0x2009	0x03	short	W/R	Same as distance instantaneous value
Measurement mode	0x200A	0x03/0x06	short	W/R	1:Listance 0:Level
Measurement unit	0x200B	0x03/0x06	short	W/R	0:m 1:cm 2:mm
Lower range limit of current output	*0x200C	0x03/0x06	short	W/R	4mA corresponding to distance value Range:0~25000, Decimal places:3 Unit:m
Upper range limit of current output	*0x200D	0x03/0x06	short	W/R	20mA corresponding to distance value Range:0~25000 Decimal places:3 Unit:m
Echo Loss of current output	*0x200E	0x03/0x06	short	W/R	0xffff:Hold value 0xfffe:20mA 0xfffd:4mA Other values: Range:0 ~ 25000 Decimal places:3 Unit:m
Condition	0x200F	0x03/0x06	short	W/R	High byte 0:Calm liquid level 1:Disturbed liquid

					2:Fast change 3:Standard solid 4:Solid dust Low byte 0:Open tank 1: Bypass pipe 2: Guide wave pipe 3:Flat top tank 4:Mixing tank
Response time	0x2010	0x03/0x06	short	W/R	0:Slow 1:Medium 2:Slow
Channel 1 alarm state	*0x2011	0x03/0x06	short	W/R	0:Off 1:High alarm 2:Low alarm
Channel 1 alarm set value	*0x2012	0x03/0x06	short	W/R	0 ~ 25000 Decimal places:3 Unit:m
Channel 1 alarm return difference	*0x2013	0x03/0x06	short	W/R	0 ~ 25000 Decimal places:3 Unit:m
Channel 2 alarm state	*0x2014	0x03/0x06	short	W/R	0:Off 1:High alarm 2:Low alarm
Channel 2 alarm set value	*0x2015	0x03/0x06	short	W/R	0 ~ 25000 Decimal places:3 Unit:m
Channel 2 alarm return difference	*0x2016	0x03/0x06	short	W/R	0 ~ 25000 Decimal places:3 Unit:m
Channel 3	*0x2017	0x03/0x06	short	W/R	0:Off

alarm state					1:High alarm 2:Low alarm
Channel 3 alarm set value	*0x2018	0x03/0x06	short	W/R	0 ~ 25000 Decimal places:3 Unit:m
Channel 3 alarm return difference	*0x2019	0x03/0x06	short	W/R	0 ~ 25000 Decimal places:3 Unit:m
Channel 4 alarm state	*0x201A	0x03/0x06	short	W/R	0:Off 1:High alarm 2:Low alarm
Channel 4 alarm set value	*0x201B	0x03/0x06	short	W/R	0 ~ 25000 Decimal places:3 Unit:m
Channel 4 alarm return difference	*0x201C	0x03/0x06	short	W/R	0 ~ 25000 Decimal places:3 Unit:m
Restore factory settings	0x2022	0x06	short	W	1:Restore factory settings

Chapter 5 Troubleshooting

When you encounter an error, if all wirings are normal through inspection in case of a fault, through the menu function to echo menu, then send us the echo picture. By this way, we can determine the possible electromagnetic interference, false echo, situation of entering a blind area, no echo signal received and other faults.

Faults	Causes	Handling
Level meter does not work.	Power supply is not well connected.	Inspect power line.
Level meter works, the system is in wave loss state. ▼ v	The measured distance exceeds the measuring range of the level meter.	Consider replacing a level meter with a larger measuring distance than the existing one
	The measured medium has strong disturbance, vibration or heavy dust.	After waiting for the measured medium to recover calm, the equipment will automatically resume .
	There are strong interference sources such as frequency converters and motors nearby.	Check the surrounding environment, do a good job of electromagnetic shielding. Do not use the same power supply as the frequency converter and the motor, but also be grounded reliably.
	The probe is not aligned with the measured plane.	Reinstall the probe perpendicular to the liquid leve.
	There are redundant objects in the measured space, such as support rods, blanking openings, etc.	Re-select the appropriate installation location to avoid interference as much as possible.

	The liquid level is in a blind area.	Raise the installation position of probe.
	The tested medium is soft powder.	Consult the manufacturer if it is powder.
	There is foam on the surface of the tested liquid, and the foam coverage area exceeds 30% within the ultrasonic irradiation range.	It is necessary to filter the foam in the water inlet part or place the ultrasonic level gauge in the wave guide to measure, so as to avoid the influence of foam.

Chapter 6 Warranty & After-sales Service

We promise to the customer that the hardware accessories provided during the supply of the instrument have no defects in material and manufacturing process. From the date of the purchase, if the user's notice of such defects is received during the warranty period, the company will unconditionally maintain or replace the defective products without charge, and all non customized products are guaranteed to be returned and replaced within 7 days.

Disclaimers:

- During the warranty period, product faults caused by the following reasons are not in the scope of Three Guarantees service
- Product faults caused by improper use by customers.
- Product faults caused by disassembling, repairing and refitting the product.

After-sales service commitment:

- We promise to deal with the customer's technical questions within 2 hours.
- For the instruments returned to the factory for maintenance, we promise to issue the test results within 3 working days and the maintenance results within 7 working days after receiving them.