

Electromagnetic flow meter

Supmea

Headquarters

5th floor, Building 4, Singapore Hangzhou Science Technology Park, No. 6 street,
Hangzhou Economic Development Area, Hangzhou 310018, China

Singapore

2 Venture Drive #11-30 Vision Exchange Singapore

✉ info@supmea.com

🌐 www.supmea.com

Supmea Automation Co., Ltd.

Preface

- Thank you for purchasing our product.
- This manual is about the various functions of the product, wiring methods, setting methods, operating methods, troubleshooting methods, etc.
- Please read this manual carefully before operation, use this product correctly to avoid unnecessary losses due to incorrect operation.
- After you finish reading, please keep it in a place where it can be easily accessed at any time for reference during operation.

Note

- Modification of this manual' s contents will not be notified as a result of some factors, such as function upgrading.
- We try our best to guarantee that the manual content is accurate, if you find something wrong or incorrect, please contact us.
- The content of this manual is strictly prohibited from reprinting or copying.

Version

U-FMC240-EN1

Safety Precautions

In order to use this product safely, be sure to follow the safety precautions described.

About this manual

- Please submit this manual to the operator for reading.
- Please read the operation manual carefully before applying the instrument. On the precondition of full understanding.
- This manual only describes the functions of the product. The company does not guarantee that the product will be suitable for a particular use by the user.

Precautions for protection, safety and modification of this product

- To ensure safe use of this product and the systems it controls, Please read carefully the operation manual and understand the correct application methods before putting into operation, to avoid unnecessary losses due to operation mistakes. If the instrument is operated in other ways not described in the manual, the protections that the instrument give may be destroyed, and the failures and accidents incurred due to violation of precautions shall not be borne by our company.
- When installing lightning protection devices for this product and its control system, or designing and installing separate safety protection circuits for this product and its control system, it needs to be implemented by other devices.
- If you need to replace parts of the product, please use the model specifications specified by the company.
- This product is not intended for use in systems that are directly related to personal safety. Such as nuclear power equipment, equipment using radioactivity, railway systems, aviation equipment, marine equipment, aviation equipment and medical equipment. If applied, it is the responsibility

of the user to use additional equipment or systems to ensure personal safety.

- Do not modify this product. The following safety signs are used in this manual:



Hazard, if not taken with appropriate precautions, will result in serious personal injury, product damage or major property damage.



Warning: Pay special attention to the important information linked to product or particular part in the operation manual.



- Confirm if the supply voltage is consistent with the rated voltage before operation.
- Do not use the instrument in a flammable and combustible or steam area.
- To prevent from electric shock, operation mistake, a good grounding protection must be made.
- Thunder prevention engineering facilities must be well managed: the shared grounding network shall be grounded at is-electric level, shielded, wires shall be located rationally, SPD surge protector shall be applied properly.
- Some inner parts may carry high voltage. Do not open the square panel in the front except our company personnel or maintenance personnel acknowledged by our company, to avoid electric shock.
- Cut off electric powers before making any checks, to avoid electric shock.
- Check the condition of the terminal screws regularly. If it is loose, please tighten it before use.
- It is not allowed to disassemble, process, modify or repair the product without authorization, otherwise it may cause abnormal operation, electric shock or fire accident.
- Wipe the product with a dry cotton cloth. Do not use alcohol, benzene

or other organic solvents. Prevent all kinds of liquid from splashing on the product. If the product falls into the water, please cut off the power immediately, otherwise there will be leakage, electric shock or even a fire accident.

- Please check the grounding protection status regularly. Do not operate if you think that the protection measures such as grounding protection and fuses are not perfect.
- Ventilation holes on the product housing must be kept clear to avoid malfunctions due to high temperatures, abnormal operation, shortened life and fire.
- Please strictly follow the instructions in this manual, otherwise the product's protective device may be damaged.



- Do not use the instrument if it is found damaged or deformed at opening of package.
- Prevent dust, wire end, iron fines or other objects from entering the instrument during installation, otherwise, it will cause abnormal movement or failure.
- During operation, to modify configuration, signal output, startup, stop, operation safety shall be fully considered. Operation mistakes may lead to failure and even destruction of the instrument and controlled equipment.
- Each part of the instrument has a certain lifetime, which must be maintained and repaired on a regular basis for long-time use.
- The product shall be scrapped as industrial wastes, to prevent environment pollution.
- When not using this product, be sure to turn off the power switch.
- If you find smoke from the product, smell odor, abnormal noise, etc., please turn off the power switch immediately and contact the company in time.

Disclaimer

- The company does not make any guarantees for the terms outside the scope of this product warranty.
- This company is not responsible for damage to the instrument or loss of parts or unpredictable damage caused directly or indirectly by improper operation of the user.

Package contents

Serial number	Item Name	Quantity
1	Electromagnetic flow meter	1
2	Manual	1
3	Certificate	1

After opening the box, please confirm the package contents before starting the operation. If you find that the model and quantity are incorrect or there is physical damage in appearance, please contact us.

Content

Chapter 1 Introduction	1
1.1. Electromagnetic flowmeter measuring principle	1
1.2. Mechanical Construction	2
1.3. Application introduction	3
Chapter 2 Safety instructions	4
2.1. Manufacturer's safety Instructions	4
2.2. Safety instructions for operators	6
2.3. Warranty & After-sales Service	6
Chapter 3 Installation	7
3.1. Installation tips	7
3.2. Storage	7
3.3. Pipeline design	7
3.4. Pipe design	7
3.5. Installation conditions	10
3.6. Mechanical installation	13
3.7. Dimensions for electromagnetic flowmeter	16
3.8. Converter dimensions	17
Chapter 4 Electrical connection	18
4.1. Safety tips	18
4.2. Connect signal and magnetic field current cable	18
4.3. Measuring sensor ground	19
4.4. Converter wiring diagram and signal definition	19
4.5. Frequency pulse output interface	20
4.6. Current output interface	22
Chapter 5 Start up	23
5.1. Power on	23

5.2. Converter start up	23
Chapter 6 Operation	24
6.1. Definition of LCD and keyboard	24
6.2. Key functions	24
6.3. Password	25
6.4. Menu	25
Chapter 7 Detailed parameter description	31
7.1. Parameter setting	31
7.2. Function Settings	32
7.3. Communication Settings	34
7.4. Output settings	34
7.5. Diagnostic test	35
7.6. System Settings	35
7.7. Calibration settings	36
Chapter 8 Technical Parameters	40
8.1. Technical Parameters	40
8.2. Electrode selection and specification	43
8.3. Flow and Velocity Parallel Table for Electromagnetic Flowmeter	44
8.4. Accuracy	45
Chapter 9 Communication	46
9.1. MODBUS-RTU Protocol	46
9.2. MODBUS Function Code	47
9.3. Data Format and Special Parameters Description	49
9.4. List of Modbus Registers	51
9.5. Modbus Communication Examples	60

Chapter 1 Introduction

1.1. Electromagnetic flowmeter measuring principle

The operating principle of electromagnetic flowmeter is based on Faraday's law of electromagnetic induction. The two electromagnetic coils at the upper and lower ends as shown in Figure 3 generate a constant or alternating magnetic field. When the conductive medium flows through the electromagnetic flowmeter, the induced electromotive force can be detected between the left and right electrodes on the wall of the flowmeter tube. The magnitude of the induced electromotive force is proportional to the electrically conductive medium flow rate, the magnetic induction density of the magnetic field, and the width of the conductor (the inner diameter of the flowmeter measuring tube), and the flow rate of the medium can be obtained by calculation. The induced electromotive force equation is as follows:

$$E=K \times B \times V \times D$$

Where: E—Induced electromotive force

K—Meter constant

B—Magnetic induction density

V—Average flow speed in cross-section of measuring tube

D—Inner diameter of measuring tube

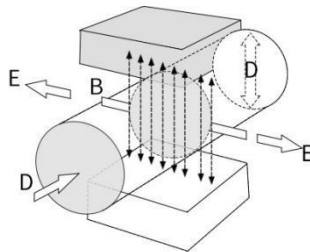

Figure 1

When measuring the flow, the fluid flows through a magnetic field which is perpendicular to the flow direction. The flow of conductive fluid induces a potential proportional to the average flow velocity, thus requiring the conductivity of the measured flowing liquid to be higher than the minimum conductivity ($5 \mu \text{ s/cm}$). The

induced voltage signal is detected by two electrodes and transmitted to the converter via a cable. After a series of analog and digital signal processing, the accumulated flow and real-time flow are displayed on the display of the converter.

1.2. Mechanical Construction

The electromagnetic flowmeter is mainly consisted of the following parts, see Figure 5.

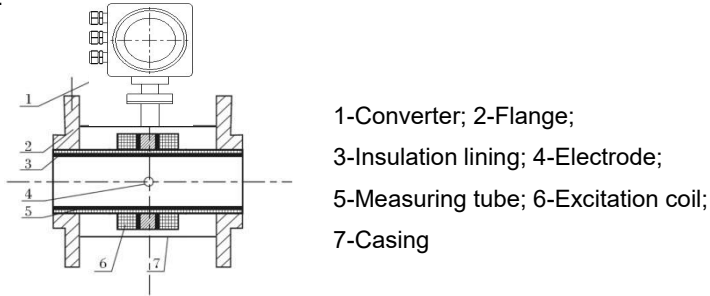

Figure 2

The electromagnetic flowmeter mainly consists of a sensor and a converter. The sensor includes a flange, a lining, an electrode, a measuring tube, an excitation coil, and a sensor casing, etc; the converter includes an internal circuit board and a converter casing.

- (1) Converter: Provide stable excitation current for the sensor, meanwhile amplify the induced electromotive force obtained by the sensor and convert it to standard electrical signals or frequency signals; at the same time, it displays real-time flow and parameters for displaying, controlling and adjusting thereof.
- (2) Flange: for connecting process piping.
- (3) Lining: Refer to a complete layer of electrically insulating corrosion resistant material located at the inner side of measuring tube and flange sealing surface.
- (4) Electrode: A pair of electrodes is installed on the wall of the measuring tube which is perpendicular to the magnetic line to detect the flow signal. The material of electrode can be selected according to the corrosion performance of the measured medium. It is also equipped with 1-2 grounding electrodes for grounding and anti-interference of flow signal

- (5) measurement.
- (6) Measuring tube: The measured medium flows through the measuring tube. It is made by welding non-magnetic stainless steel and flange, and the inner side is equipped with insulation lining.
- (7) Excitation coil: A group of coils is arranged on the upper and lower side of external side of the measuring tube respectively to generate a working magnetic field.
- (8) Casing: Protect and seal the meter.

1.3. Application introduction

Electromagnetic flowmeter applies only to measure the real-time flow rate of an electrically conductive liquid or liquid-solid two-phase flow, and has a flow accumulation function. Theoretically, an ordinary type electromagnetic flowmeter can measure the medium conductivity of not less than $5 \mu \text{ S/cm}$, but it's proved that the measured conductivity by the ordinary electromagnetic flowmeter is higher than one to two orders of magnitude, at least more than $30 \mu \text{ S/cm}$. Meanwhile, the conductivity measured online must prevail, for that measured offline may be relatively higher due to carbon dioxide and nitrogen dioxide contained in the air may dissolve into the medium.

Chapter 2 Safety instructions

2.1. Manufacturer's safety Instructions

2.1.1. Copyright and data protection

The content of this document has been checked carefully, but we do not guarantee that the contents are totally accurate and it is in accordance with the latest version.

The contents and works of this document are under China's copyright protection.

Any copy, processing and transmission of it out of the scope of copyright, in any forms, must get the written permission of the authors or the manufacturer.

Manufacturers always try to respect the copyrights of others, and try to use their own works or works without authorization.

Personal data (such as name, address or E-mail address) used in manufacturer's documents, if possible, are conducted on a voluntary basis. Use of products and services, if possible, starts without having to provide personnel data. We remind you: data transmission on the Internet (such as communicating via email) may possibly meet security vulnerabilities. We can't give security guarantee that data will definitely not be obtained by a third party. Here, we are clearly against the third party using contact data, within the scope of copyright notice obligation, to send advertising materials without any requirement.

2.1.2. Exemption clause

The manufacturer will not bear the responsibility for any forms of loss caused by using the product; these consequences include direct, indirect or accidental losses as well as these coming from punishment, but not limited to these consequences.

If the manufacturer has intentional behavior or gross negligence, the disclaimer is invalid. If it is not allowed to limit the product's self assurance, nor is it allowed to waive or limit certain types of compensation, and these rights are suited for you as well according to applicable laws, in this case the above disclaimer or limitations may partially or completely not apply to you.

For every purchase of products, they are applicable to product documentation and manufacturer's sale terms.

As for document contents including this disclaimer, the manufacturer reserves and has the right to modify at any time in any way for any reason without any notice in

advance, and it will not bear the responsibility for the consequences coming out of any forms of change.

2.1.3. Product liability and warranty

The operator judges whether the flow meter serves the purpose, and bear the responsibility for it. The manufacturer does not assume the consequences caused by operator's misuse of meter. Wrong installation and operation of flowmeter (system) will lead to deprive of warranty rights. In addition, the corresponding 'standard sales terms' applies as well, and the clause is the basis of purchase contract.

2.1.4. Document details

In order to avoid harm or damage to the equipment when used improperly, please make sure reading the information in this document before using it. In addition, you must comply with national standards, safety regulations and accident prevention rules. If you can't understand this document, please ask the manufacturer for help. The manufacturer will not take the responsibility for property loss or physical injuries due to misunderstanding of the information contained in the document. This document will help you to establish favorable operating conditions so as to make sure that you use the equipment in a safe and effective way. In addition, something of particular attention and safety measures in the document are marked by the following marks.

2.1.5. Display convention

The following symbols will make it easier for you to use this document.



Danger!

This symbol signifies related and important safety tips.



Warning!

Such warnings must be paid attention to. Slight negligence may lead to serious health threat, and may damage the equipment itself or the operating factory facilities.



Note!

Such warnings must be paid attention to. Any slight negligence may also lead to functional fault of the equipment itself.

2.2. Safety instructions for operators



Warning!

Only corresponding personnel who got trained and authorized is allowed to install, use, operate and maintain the equipment. This document will help you to establish favorable operating conditions so as to make sure that you use the equipment in a safe and effective way.

2.3. Warranty & After-sales Service

We promise to the customer that the hardware accessories provided during the supply of the instrument have no defects in material and manufacturing process. From the date of the purchase, if the user's notice of such defects is received during the warranty period, the company will unconditionally maintain or replace the defective products without charge, and all non customized products are guaranteed to be returned and replaced within 7 days.

Disclaimers:

- During the warranty period, product faults caused by the following reasons are not in the scope of Three Guarantees service
- Product faults caused by improper use by customers.
- Product faults caused by disassembling, repairing and refitting the product.

After-sales service commitment:

- We promise to deal with the customer's technical questions within 2 hours.
- For the instruments returned to the factory for maintenance, we promise to issue the test results within 3 working days and the maintenance results within 7 working days after receiving them

Chapter 3 Installation

3.1. Installation tips

**Note!**

Please check whether the boxes are damaged or not, and whether they have been handled roughly or not. Please report the damage to the courier service and the manufacturer.

**Note!**

Please check the packing list to make sure the batch of goods that you have received is complete.

**Note!**

Please check the instrument nameplate, and confirm whether the delivered contents are consistent with your order. Check whether the power supply indicated on the nameplate is correct. If not correct, please contact the manufacturer.

3.2. Storage

- (1) The instrument shall be stored in a dry and clean place.
- (2) Avoid exposure in direct sunlight for long.
- (3) Instrument shall be stored in the original package.

3.3. Pipeline design

The following items shall be considered when the pipes are designed.

- (1) Leave enough space on the side.
- (2) Do not make the electromagnetic flowmeter subject to violent vibration.

3.4. Pipe design

(1) Location

- ① The electromagnetic flowmeter shall be installed in a dry and ventilated place. Places that could be flooded should be avoided.
- ② The electromagnetic flowmeter shall avoid the sunshine and rain. When it is installed outdoors, it shall be equipped with facilities against sunshine and

rain. The ambient temperature ranges from -20°C to $+60^{\circ}\text{C}$.

- ③ The electromagnetic flowmeter shall not be installed in places with large temperature variation and avoid high temperature radiation from the equipment. If it must be installed therein, heat insulation and ventilation measures shall be taken.
- ④ The electromagnetic flowmeter shall avoid installing in an environment containing corrosive gases. If it must be installed therein, ventilation and anti-corrosion measures shall be taken.
- ⑤ The electromagnetic flowmeter shall be installed avoiding strong vibration as possible, such as violent pipe vibration. In this case, brackets for fixing pipes on both sides of electromagnetic flowmeter shall be provided.
- ⑥ Part of the sensor of electromagnetic flowmeters with IP68 (3 m under water) protection level can be placed into the water. While the electromagnetic flowmeter with IP65 protection level cannot be immersed into the water or installed outdoors.

(2) Avoid interference of magnetic field

Do not install electromagnetic flowmeters near motors, transformers, or other power sources which are prone to cause electromagnetic interference, near the frequency converter or obtain power from the power distribution cabinet of the frequency converter to avoid interference.

(3) The distance of the straight pipe

In order to ensure the measurement accuracy of flowmeter, it is recommended to ensure that the length of the straight pipe on the upstream of the sensor shall be at least 10 times of pipe diameters (10D), and the length of straight pipe on the downstream be at least 5 times of pipe diameters (5D)

(4) Maintenance space

For the convenience of installation and maintenance, enough installation space shall be reserved around the electromagnetic flowmeter.

(5) For pipes that do not allow flow disruption in the process

When installing the electromagnetic flowmeter, bypass pipes and cleaning ports shall be added. As shown in Figure 3, these devices can ensure the continuous operation of equipment system when the flowmeter is out of service.

(6) Support of electromagnetic flowmeter

Do not install the electromagnetic flowmeter on a free-vibrating pipe without any support. Instead, a mounting base shall be used to secure the measuring tube. When the electromagnetic flowmeter is required to be installed underground, the pipes at both inlet and outlet ends shall be provided with support items, and a metal protection plate shall be installed above the flowmeter.

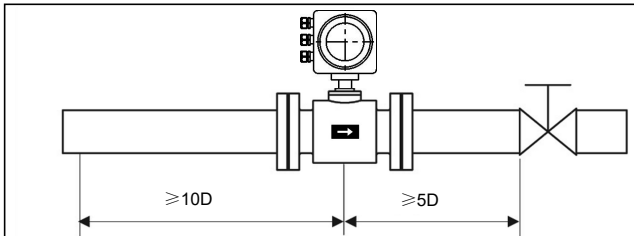

Figure 3

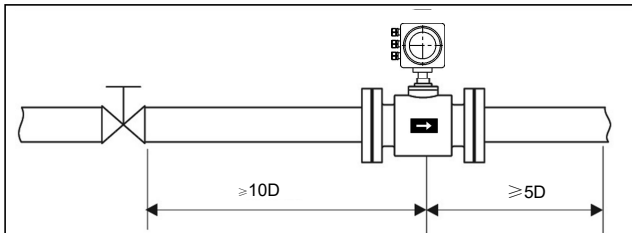

Figure 4

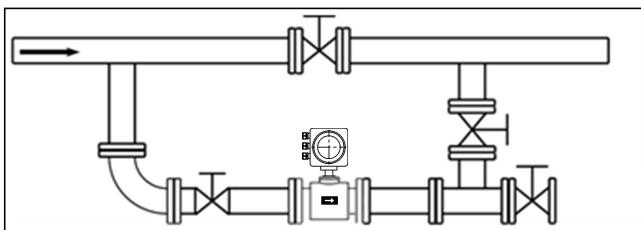

Figure 5

3.5. Installation conditions

(1) Flow direction

The flowmeter can be set to automatically detect the positive and negative flow direction. The flow direction arrow on the sensor casing indicates the positive flow direction specified by the manufacturer. Generally, when installing the meter, the user shall make the flow arrow consistent with the on-site process flow.

Figure 6 shows the preferred location for installing the electromagnetic flowmeter.

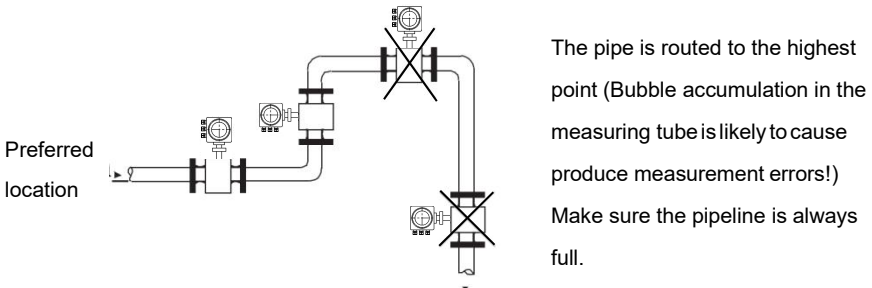

Figure 6

(2) Installation direction of electromagnetic flowmeter and sensor electrodes

The sensor allows horizontal and vertical installation. When it's installed horizontally, the electrode shall be horizontally placed such that bubbles will not be adsorbed near the electrode in case that the medium is contained with bubbles or precipitates. Otherwise, this would cause converter signals opened and zero drift due to the fact that deposits are not covered by the electrode.

(3) Liquids shall always be filled with pipes.

Pipes shall be arranged to ensure that the electromagnetic flowmeter measuring tube is always filled with liquids.

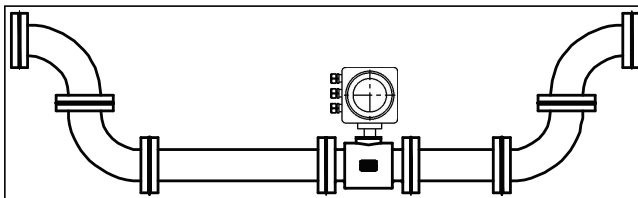

Figure 7

In case of liquids or suspensions containing solid particles, it is recommended to install electromagnetic flowmeters vertically. For one thing, the phase separation of measured medium can be prevented; for another, the sensor lining is worn evenly. In addition, impurities will not precipitate at the bottom of the measuring tube. It shall be guaranteed that liquids flow from bottom to top to ensure that the sensor measuring tube is always filled with medium.

(4) The electromagnetic flowmeter cannot be installed on the suction side of the pump.

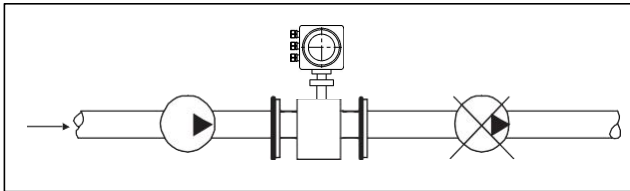

Figure 8

(5) For long pipelines, control valves are generally installed on the downstream of the electromagnetic flowmeter.

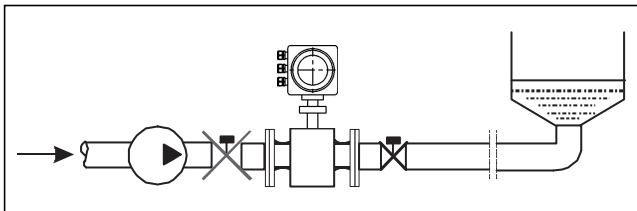

Figure 9

(6) For pipes with open discharges, the electromagnetic flowmeter shall be installed at the bottom section (lower part of the pipe).

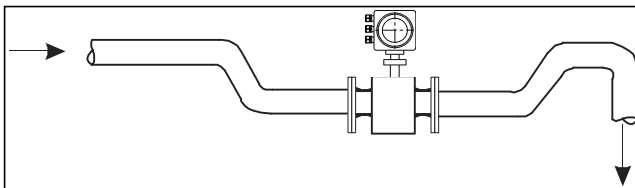

Figure 10

(7) For places where fall head of pipes is over 5 m, the air valve shall be installed on the downstream of the electromagnetic flowmeter.

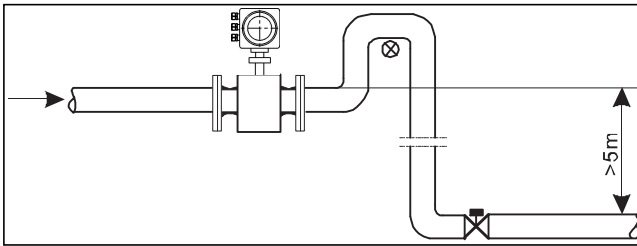

Figure 11

(8) Measurement errors caused by the ingress of foreign gas and damage to the lining caused by vacuum should be avoided.

(9) No bubbles shall be observed in the pipes.

Pipes shall be designed to prevent the air bubbles in the fluids from accumulating the measurement pipe of a sensor. If a valve exists near the flowmeter, try to mount the flowmeter on the valve's upstream side for preventing a decrease of pressure inside the pipe possibly, consequently avoiding the possibility of air bubbles. ensure that no gas can be separated from the liquid.

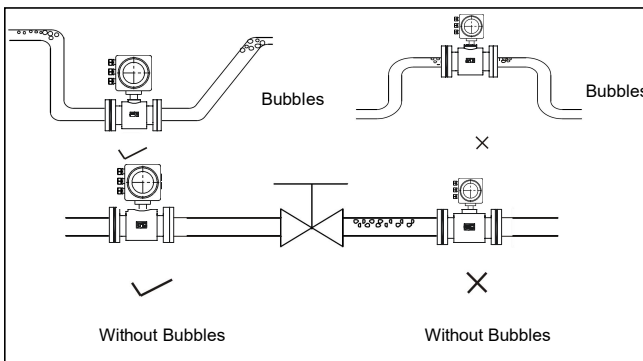

Figure 12

(10) Liquid conductivity

It's not allowed to install the electromagnetic flowmeter at a place where the liquid

conductivity is extremely uneven. Injection of chemicals from the upstream of the meter can easily result in uneven liquid conductivity, which can cause serious interference to the meter flow indication. In this case, it is recommended to inject chemicals from the downstream of the meter; if chemicals must be injected from the upstream of the meter, it must be ensured that the straight pipe section on the upstream at least has 30 times of pipe diameters to ensure adequate mixing of liquids.

(11) Grounding

As the voltage of induced signal of electromagnetic flowmeter is small, it's more prone to be affected by noises or other electromagnetic signals. This is why the electromagnetic flowmeter needs to be grounded in many occasions. This functions to form an internal space for shielding external interference through the grounding of flowmeter casing, thereby improving measurement accuracy.

3.6. Mechanical installation

3.6.1. Installation of flowmeter pipeline

(1) Prior to installation, the pipeline shall be calibrated to ensure that the diameter of the meter has good coaxiality with the user's pipeline. For sensors with a nominal diameter of no more than 50mm, the protrusion of its axis shall not exceed 1.5 mm; for sensors with a nominal diameter of 65~300 mm, it shall not exceed 2mm and for sensors with a nominal diameter of no less than 350 mm, it shall not exceed 4 mm.

(2) In general, foreign particles (such as welding slag) may exist in newly installed pipelines. Before the flowmeter is installed, wash away the debris. It not only prevents the lining from being damaged but also measurement error caused by foreign particles which pass through the measuring tube during measurement.

3.6.2. Precautions

Operating introduction:

(1) Take care to avoid damage to the meter when you are unpacking. It is suggested not to unpack the box before transporting it to the installation site to avoid damage of meter. It's prohibited to use a stick or rope to lead through the

measuring tube of sensor. Instead, follow the correct lifting as shown in the figure below.

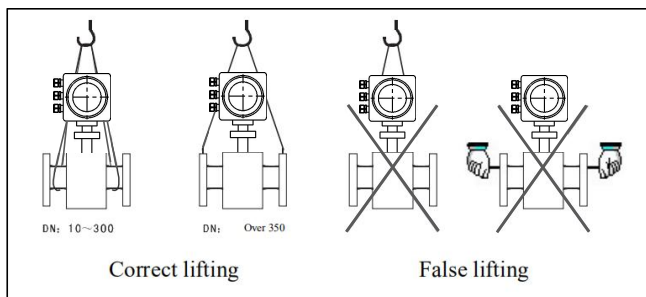

Figure 13

(2) Avoid vibration

Avoid heavy falling or pressing, especially the flange surface which cannot be stressed (otherwise, the lining may be damaged to disable operation of the meter).

(3) Protection of flange surface

After unpacking, pay attention to protect the flange. Do not place it on the unpadded floor or other uneven boards.

(4) Terminal box

It's not allowed to seal the terminal box cover before electrical wiring. After the wiring is completed, please apply the special sealant provided by our company to on the terminal box as soon as possible. Then cover terminal box and tighten the screws to ensure the tightness.

If the protection level of the electromagnetic flowmeter is IP68 at type selection, it has been subject to water-proof sealing.

(5) No operation for long duration

After the instrument is installed, it shall be avoided that the meter is not checked for long duration. If yes, please take the following measures:

- A. Check the tightness of the covers and the wiring terminals to ensure that no moisture and water enters into the meter.
- B. Conduct regular inspection. Check against the measures mentioned above

and the terminal box for at least once a year. In the event of water entry into the meter (eg, after heavy rain, etc.), the meter shall be inspected immediately. Installation of flowmeter

3.6.3. Installation of flowmeter

(1) Installation direction

The flow direction of the measured fluid shall be consistent with flow direction mark indicated on the flowmeter.

(2) Seal gaskets installed between flanges shall have good corrosion resistance and shall not protrude into the interior of the pipe.

(3) When welding or flame cutting is performed adjacent to sensor pipe, isolation measures shall be taken to prevent the lining from being deformed due to heat.

(4) If it is installed in a well or immersed in water, apply sealant on the terminal box of the sensor after the system is installed and debugged. (If the protection level of the electromagnetic flowmeter is IP68 at type selection, it has been subject to water-proof sealing.)

(5) When the flowmeter is installed on the field, use bolts to connect the flange on the sensor to that on the pipe. Bolts, nuts and their threads for securing meters shall be complete and free of damage and well lubricated. Use them with suitable flat washers and spring washer. A torque wrench shall be used to tighten the bolts according to the flange size and torque. Regularly tighten the bolts during daily use to prevent looseness of the bolts.

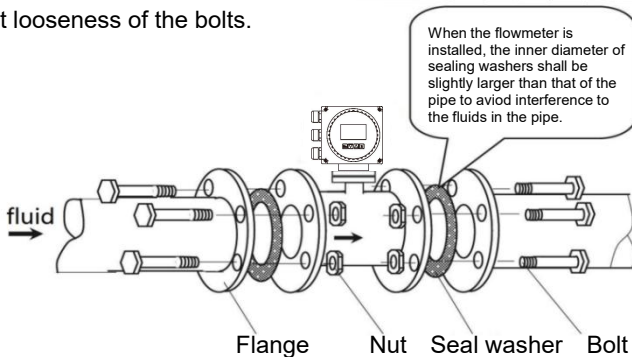
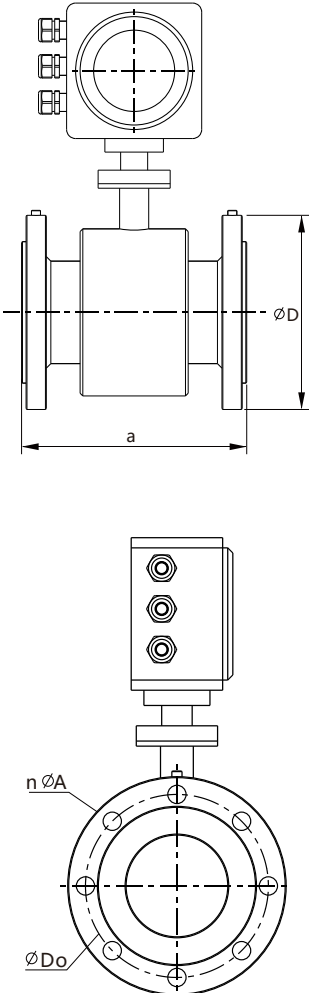

Figure 14

3.7. Dimensions for electromagnetic flowmeter

Table 1

	DN	a	D	Do	n*∅A	Pressure resistance
	10	200	90	60	4*14	1.6Mpa
15	200	95	65	4*14		
20	200	105	75	4*14		
25	200	115	85	4*14		
32	200	135	100	4*18		
40	200	145	110	4*18		
50	200	160	125	4*18		
65	200	180	145	4*18		
80	200	195	160	8*18		
100	250	215	180	8*18		
125	250	245	210	8*18		
150	300	280	240	8*23		
200	350	335	295	12*23		
250	450	405	355	12*25		
300	500	440	400	12*23	1Mpa	

3.8. Converter dimensions

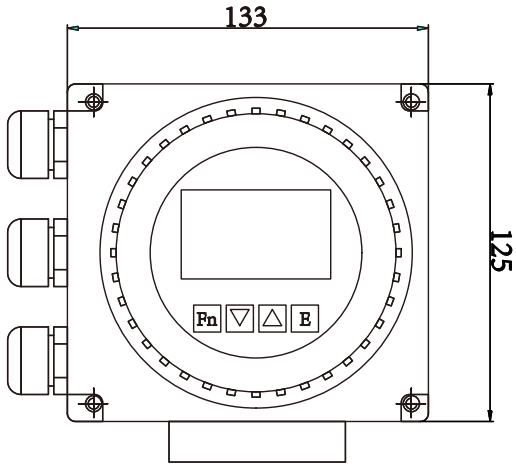

Figure 15 Compact type

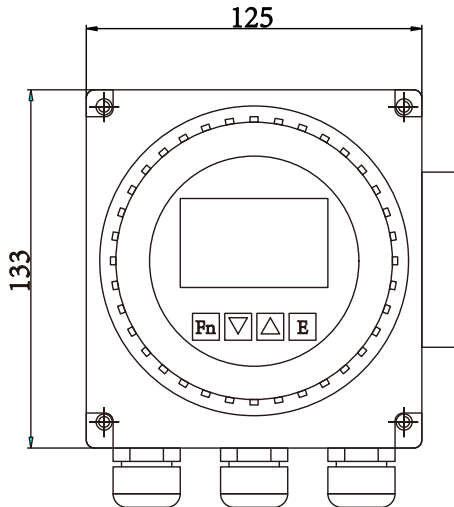

Figure 16 Remote type

Chapter 4 Electrical connection

4.1. Safety tips



Danger!

Only when the power is switched off, can we do all the work about electrical connections. Please pay all attention to the power supply on the nameplate!



Danger!

Please observe national installation regulations



Warning!

Please strictly observe local occupational health and safety regulations. Only those who have got properly trained are allowed to operate on the electrical equipment.



Tips!

Please check the nameplate of the equipment, and confirm whether the delivered contents are consistent with your order, and check whether the voltage indicated on the nameplate is correct. Otherwise, please contact manufacturer or supplier.

4.2. Connect signal and magnetic field current cable



Danger!

Only when the power is cut off can you connect signal and magnetic field current conductor.



Danger!

The equipment must be grounded in accordance with regulations so as to protect the operator from electrical shock.



Danger!

In case that equipment is used in explosion danger areas, special notes are given to explosion-proof instructions for safety tips.

4.3. Measuring sensor ground



Warning!

Please strictly observe local occupational health and safety regulations. Only those who have got properly trained are allowed to operate on the electrical equipment.

- (1) The measuring sensor must be properly grounded;
- (2) The ground wire should not transmit any interference voltage;
- (3) Other electrical devices are not allowed to be connected to the ground wire at the same time.

4.4. Converter wiring diagram and signal definition

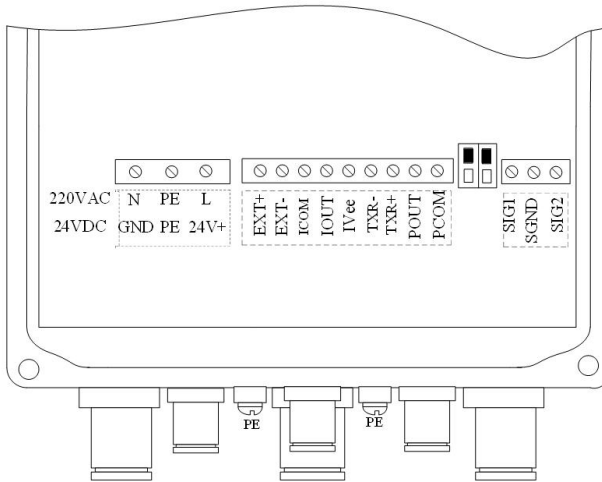

Figure 17

Connect the sensor:

SIG 1: Signal 1

SGND: signal ground

SIG 2: Signal 2

EXT + : Excitation current +

EXT - : Excitation current-

Current output:

IVee: Current output power supply

IOUT: Current output

ICOM: Current output ground

Frequency or pulse output:

POUT: Frequency (pulse) output

PCOM: frequency (pulse) output ground

Communication output:

TXR+: Communication input (485+)

TXR -: Communication input (485-)

4.5. Frequency pulse output interface

Frequency output and pulse output share a set of terminals POUT (P+) and PCOM (P-), select frequency or pulse output through the menu. Frequency/pulse output supports three output modes.

Output mode 1: OC gate passive output, the user equipment is connected to a pull-up resistor.

The two on-board DIP switches of the split type converter (red DIP switches in the wiring cavity) are all turned outward (OFF position), and the two-position DIP switches of the integrated wiring board are all turned down (OFF position) .

POUT (P+) output frequency/pulse signal.

The external power supply V+ can be 5V/12V/24V, and the resistance value of the pull-up resistor R ranges from 2k to 10k.

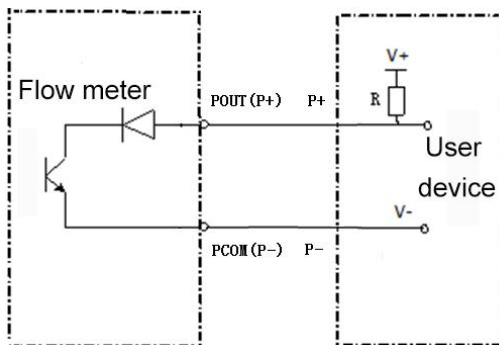

Figure 18

Output mode 2: OC gate passive output, user equipment connected to pull-down resistor.

The two on-board DIP switches of the split type converter (red DIP switches in the wiring cavity) are all turned outward (OFF position), and the two-position DIP switches of the integrated wiring board are all turned down (OFF position)
PCOM (P-) output frequency/pulse signal.

POUT (P+) is directly connected to the external power supply V+.

This mode is more common in the combined system of flowmeter and PLC

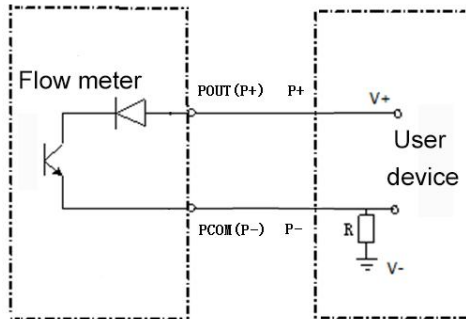

Figure 19

Output mode 3: Active output in level mode, which can directly drive the load.

The two-position DIP switches on the board of the split converter (the red DIP switch in the wiring cavity) are all turned inward (ON position), and the two-position DIP switches of the integrated wiring board are turned up (ON position) .

POUT (P+) output frequency/pulse signal.

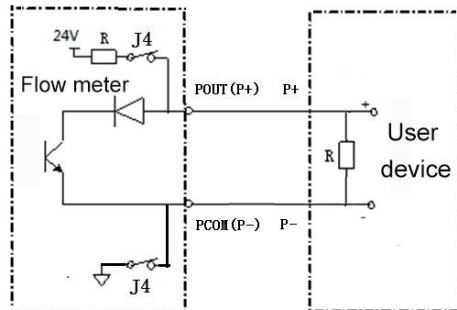

Figure 20

4.6. Current output interface

The current output is designed with a high-precision large-scale integrated circuit chip, without zero and full scale calibration, the output is stable and reliable, and has good interoperability and temperature stability.

The current output has three terminals IOUT(I+), ICOM(I-) and IVee, and supports two current output modes: two-wire active current output and two-wire passive current output.

Output mode 1: two-wire active current output

The connection terminals are IOUT(I+) and ICOM(I-)

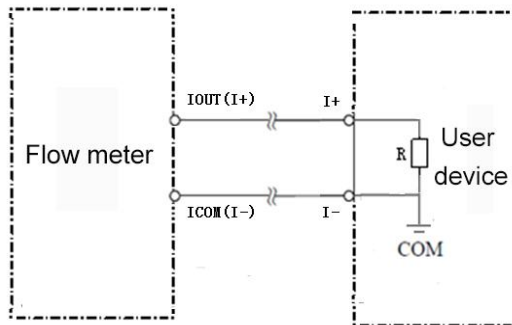

Figure 21

Output mode 2: two-wire passive current output

The terminals are IOUT(I+) and IVee.

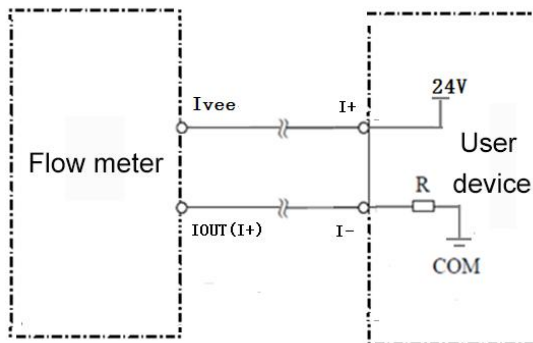

Figure 22

Chapter 5 Start up

5.1. Power on

Please check whether the installation is correct before power on, including:

- ① The meter must be installed following safety compliance.
- ② Power supply connection must be performed in accordance with the regulations.
- ③ Please check the electrical connection in the power supply is correct.
- ④ Tighten the converter shell back cover.
- ⑤ Tighten the back cover of the converter housing

5.2. Converter start up

The measuring instrument is consisted of measuring sensor and signal converter; the delivery can be put into service. All parameters and hardware are configured according to your order.

After energization, the instrument will perform self-check for one time.

Then it will immediately begin to measure and display the current values.

Chapter 6 Operation

6.1. Definition of LCD and keyboard

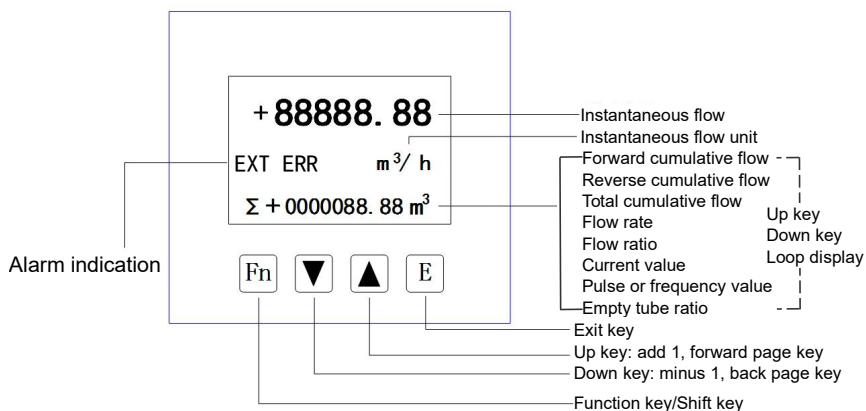

Figure 23

After the instrument is powered on, it enters the automatic measurement state, realizes various measurement functions and displays the corresponding measurement data. By operating the four panel keys, the instrument parameters can be set and displayed.

6.2. Key functions

The instrument has four keys, which are up key, down key, function key/shift key and exit key.

Up key: add 1 to the number at the cursor, and cycle to select the content displayed on the upper line of the screen.

Down key: the number at the cursor is reduced by 1, and the content displayed in the lower part of the screen is cyclically selected.

Function key/shift key: In the parameter editing interface, the cursor moves to the right. In the non-parameter editing interface, enter the lower submenu, and in the measurement interface, enter the main menu.

Exit key: in the parameter editing interface, choose to save the parameter or exit directly (there must be addition and subtraction or shift operation, otherwise it will return to the upper-level submenu directly). In the non-parameter editing interface,

return to the upper submenu;

When editing parameters, use the function key/shift key to perform the shift operation, use the up and down keys to perform addition and subtraction operations, and use the exit key to select whether to save the parameter or exit directly without saving.

6.3. Password

The meter is designed with a 3-level password. Level 1 password can modify the password value of this level; Level 2 password can modify the password of this level, you can view the password value of Level 1; Level 3 password can modify the password of this level, you can view the password value of Level 1 and Level 2. The factory values of Level 1 and Level 2 are "10000" and "40000" respectively. After entering the menu with the password, you can operate the corresponding password level, and the exit key can return to the main screen, and you can directly enter the menu without a password within 5 minutes (enter any password on the password input screen, press the exit key, and then press the function key to directly enter the menu.).

6.4. Menu

The meter menu list is shown below.

Table 2

First level menu	Secondary menu	Tertiary menu
Parameter settings	Measuring pipe diameter	10mm~300mm
	Damping time	0~99s
	Flow unit	L/h、L/m、L/s、m ³ /h、m ³ /m、m ³ /s、t/h、t/m、t/s、kg/h、kg/m、kg/s、GPH、GPM、GPS、BBL/m、BBL/h、CF/s、CF/m、CF/h、AF/m、AF/H
	Flow decimal places	Automatic, manual; when manually set, the instantaneous flow can be set to 0~3 decimal places
	Flow Accumulation	0.001m ³ 、0.01m ³ 、0.1m ³ 、1m ³ 、0.001L、0.01L、0.1L、1L、1t、1kg、10 ¹ m ³ 、10 ² m ³ 、

	Unit	10 ³ m ³ 、 GAL、 BBL、 CF、 AF
	Meter range	Setting, unit adjustable
	Excitation frequency	1/4, 1/8, 1/16 power frequency
	Excitation current	Read only
	Fluid density	Set up
Function settings	Measurement direction	Forward and Reverse
	Reverse measurement	Allow or Prohibit
	Reverse output	Allow or Prohibit
	One-click reset	Allow or Prohibit
	Small signal ablation	Allow or Prohibit
	Small signal cutoff point	Set up
	Spike suppression time	Set up
	Spike Suppression Threshold	Set up
	Spike Suppression Enable	Allow or Prohibit
	Strong steady flow	Allow or Prohibit
	Strong steady flow coefficient	Set up
	Excitation alarm	Allow or Prohibit
	Empty Traffic Alarm	Allow or Prohibit
	Empty pipe alarm threshold	Set up

	Upper limit alarm	Allow or Prohibit
	Upper alarm threshold	Set up
	Lower limit alarm	Allow or Prohibit
	Lower alarm threshold	Set up
Communication	Modbus communication	Communication address setting
		Communication response delay
		Communication baud rate setting
		Communication check digit setting
Output settings	Pulse output type	Pulse, frequency
	Maximum pulse width enable	Allow or Prohibit
	Current full scale fine-tuning	Set up
	Current zero trimming	Set up
	Pulse polarity	Positive, negative
	Pulse unit equivalent	The unit is L, which can be set between 0.001L~10000.000L
	Pulse width setting	Optional automatic or manual mode, manual mode can be set
	Frequency output range	0~10000Hz
Diagnostic test	(4~20)A output test	Simulate current output
	Flow Test	There are flow states in the simulated pipeline (frequency, pulse and current have outputs)

	Pulse output test	Simulate pulse output
	Frequency output test	Simulate frequency output
Record query	Start and stop records	Valid only in power-down logging models
	Cumulative monthly record	Valid only in power-down logging models
	Cumulative daily record	Valid only in power-down logging models
System settings	Software version	Read only
	Reset	Restore factory parameter settings
	Save factory settings	Save the parameters set at the factory
	LCD contrast setting	Set up
	Positive total preset	Set up
	Reverse total preset	Set up
	The accumulated total is cleared	Accumulated flow reset
	Password display	Display level 1, 2 and 3 password values
	Password setting	Set level 1, 2 and 3 password values
Calibration settings	Flow Zero Correction	Set up
	Automatic zero point correction	Allow or Prohibit
	Automatic	Set up

	correction time		
	Sensor factor	Set up	
	Sensor coefficient calculation	Enter the standard flow, automatically calculate and automatically save the sensor coefficient	
	Converter normalization factor	Set up	
	Flow linear correction allows	Allow or Prohibit	
	Flow linearity correction point	Set up	
	Flow linear correction value	Set up	
	Flow Segment Correction Settings	Flow correction unit	m ³ /h、m ³ /m、m ³ /s、kg/h、kg/m、kg/s、t/h、t/m、t/s、GPM、m/s、L/h、L/m、L/s
		Flow correction point 1	Set up
		Standard flow 1	Set up
		Flow correction point 2	Set up
		Standard flow 2	Set up
		Flow correction point 3	Set up
		Standard flow 3	Set up
		Flow correction	Set up

		point 4	
		Standard flow 4	Set up
		Flow correction point 5	Set up
		Standard flow 5	Set up
	Flow Segmentation Correction Allowed	Allow, forbid; the submenu in the flow correction setting can take effect only when allowed	

Chapter 7 Detailed parameter description

7.1. Parameter setting

Measuring pipe diameter:

Electromagnetic flowmeter converter supporting sensor diameter range:
DN10~DN300

At the same time, you can set the caliber fine-tuning, which is used for non-universal calibers or when the caliber error is large. e.g. 50 - 01 mm (49 mm) 50 + 01 mm (51 mm)

Damping time settings:

Long measurement damping time can improve the stability of meter flow display and output signal, and is suitable for total cumulative pulsating flow measurement. Short measurement damping time shows fast measurement response speed, which is suitable for production process control. The measurement damping time can be set arbitrarily between 1-99.

Flow unit:

Select the flow display unit in the parameters. The flow display unit of the instrument is: L/s, L/m, L/h, m³/s, m³/m, m³/h, etc. Users can select a suitable flow display unit according to process requirements and usage habits.

Flow decimal place setting:

When setting the decimal display digits of the instantaneous flow rate, it is divided into automatic setting and manual setting.

In the automatic setting state, the decimal places of the instantaneous flow are automatically selected according to the size of the aperture;

In the manual setting state, the decimal places of instantaneous flow are set according to user settings, and 0, 1, 2, and 3 decimal places can be set; Users can set according to different application conditions and different measurement ranges.

Flow accumulation unit:

The converter display is a 9-digit counter, and the maximum allowed count value is 999999999. The cumulative unit used is L, m³ (liter, cubic meter), etc.

Meter range:

The instrument range setting refers to determining the upper limit flow value, and the lower limit flow value of the instrument is automatically set to "0". Therefore, the meter range setting determines the meter range range, and also determines the corresponding relationship between the meter percentage display, the meter frequency output, the meter current output and the flow rate:

Percentage value = (flow measurement value / meter range) * 100 %;

Frequency output value = (flow measurement value / meter range) * frequency full scale value;

Current output value = (flow measurement value / meter range) * current full scale value + base point;

The instrument pulse output value is not affected by the instrument range setting;

Excitation frequency: 1/4, 1/8, 1/16 power frequency

Fluid density

7.2. Function Settings

Measurement direction selection:

If the user thinks that the fluid direction during debugging is inconsistent with the design, the user does not need to change the connection of the excitation line or the signal line, but just use the flow direction to set the parameters to change.

Reverse measurement allows:

The user chooses to allow or prohibit.

When the reverse output allowable parameter is set to the "allowed" state, as long as the fluid flows, the converter measures and displays the fluid flow in real time.

When the flow value is negative, it means the fluid flows in reverse. When the reverse measurement allowable parameter is set to "prohibit", if the fluid flows in reverse, the flow display data is "0".

Inverted output allows:

The user chooses to allow or prohibit.

When the reverse output allow parameter is set to the "allow" state, as long as the fluid flows, the converter outputs pulses and currents according to the flow value.

When the reverse output allowable parameter is set to "prohibit", if the fluid flows

in the reverse direction, the output pulse of the converter is "0", and the current output is a signal of 4mA.

Small signal cut-off:

The user chooses to allow or prohibit.

When the allowable cut-off display parameter is set to "allow", when the flow percentage is less than or equal to the small signal cut-off point, the flow is cut off and displayed as "0". When the cut-off display parameter is set to "Disabled", no cut-off is performed regardless of the flow percentage.

Small signal cut-off point:

The small signal cutoff point setting is expressed in percent flow of span. When the small signal is cut off, the display and signal output of flow rate, flow rate and percentage are cut off at the same time.

Strong steady flow allows:

The user chooses to allow or prohibit.

Strong steady flow coefficient:

set up.

The excitation alarm allows:

The user chooses to allow or prohibit.

Empty pipe alarm allows:

The user chooses to allow or prohibit.

The converter features empty pipe detection and no additional electrodes are required. If the user chooses to allow the empty pipe alarm, the instrument can detect an empty pipe state when the fluid in the pipeline is lower than the empty pipe measurement threshold. After the empty pipe state is detected, the analog output and digital output of the instrument are set to signal zero, and the flow rate of the instrument is displayed as zero.

Empty pipe alarm threshold:

When the fluid is full (with or without flow rate), the user can adjust the empty pipe alarm threshold according to the "empty pipe ratio" data on the measurement page.

The upper limit alarm allows:

The user chooses to allow or prohibit.

Upper alarm threshold:

The upper limit alarm value is calculated as a percentage of the range. This parameter adopts a numerical setting method, and the user sets a value between 0% and 199.9%. When the alarm conditions are met during the operation of the instrument, the instrument will output an alarm signal.

The lower limit alarm allows:

The user chooses to allow or prohibit.

Lower alarm threshold:

Same as upper alarm threshold

7.3. Communication Settings

Modbus communication settings

- Communication address settings:

Refers to the communication address of this watch during multi-machine communication. The optional range is: 01 ~ 99 addresses, and address 0 is reserved.

- Communication baud rate setting:

Instrument communication baud rate selection range: 300, 600, 1200, 2400, 4800, 9600, 19200.

- Communication check digit setting:

Can be set to no parity, odd parity and even parity.

7.4. Output settings

Pulse output type:

There are two options for pulse output: frequency output and pulse output:

Frequency output: The frequency output is a square wave, and the frequency value corresponds to the flow percentage.

Frequency value = (flow measurement value / meter range) * frequency full scale value;

Pulse output: The pulse output is a rectangular wave pulse train, each pulse represents a flow equivalent flowing through the pipeline, and the pulse equivalent is selected by the "pulse unit equivalent" parameter. The pulse output mode is

mostly used for total accumulation, which is generally connected with the totalizing instrument.

Pulse unit equivalent:

Pulse unit equivalent refers to the flow value represented by one pulse, and the selection range of pulse equivalent is 0.001L~10000L.

Note: Under the same flow, the pulse equivalent is small, the frequency of the output pulse is high, and the accumulated flow error is small.

Pulse Width:

Set the pulse width of the instrument pulse output, the unit is ms. Users can arbitrarily set between 0.1ms and 100ms according to the application conditions.

Frequency output range:

The meter frequency output range corresponds to the upper flow measurement limit, which is 100% of the percent flow. The upper limit of the frequency output can be set arbitrarily within the range of 1Hz to 10000Hz.

7.5. Diagnostic test

4-20mA output test

Flow Test

Pulse output test

Frequency output test

7.6. System Settings

LCD contrast setting

Positive total flow preset

The positive total preset setting can change the value of the positive cumulative total, which is mainly used for instrument maintenance and instrument replacement.

Reverse total flow preset

The reverse total amount preset setting can change the value of the reverse accumulated total amount, which is mainly used for instrument maintenance and instrument replacement.

The accumulated total is cleared

Password display

The user can use the high-level password to query the password value of the low-level password.

Password setting

Users can use the original password for each level to set a new password for the current level respectively.

7.7. Calibration settings

Flow zero correction:

During zero point correction, make sure that the sensor tube is filled with fluid and the fluid is in a static state. The zero point of flow is expressed in terms of flow velocity in mm/s.

The converter flow zero correction is displayed as follows:

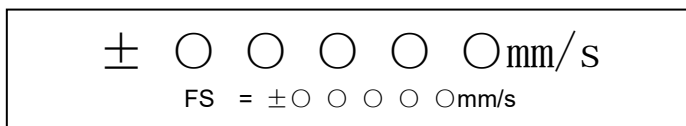

Figure 24

* Lower display: FS represents the actual measured value of the zero point of the instrument;

* Up display: flow rate zero correction value;

* Note: FS is the actual measurement value of the instrument, which is not affected by the zero point correction value. In the process of use, just adjust the zero point correction value to be consistent with the size of FS, and in the opposite direction.

The correction value of the flow zero point is the matching constant value of the sensor, which should be recorded in the sensor record sheet and sensor label.

When recorded, the sensor zero value is the flow velocity value in mm/s, and its sign is opposite to that of the correction value.

Automatic zero point correction: enable or disable.

Automatic correction time: the time for automatically calculating the zero point correction value, which can be set within 10~99 seconds.

Sensor factor:

Sensor coefficient: the calibration coefficient of the whole electromagnetic flowmeter. The coefficient is obtained from the real standard and marked on the

sensor plate. The user must place this factor in the converter parameter table.

Sensor coefficient calculation:

It is used to automatically calculate the calibration coefficient (sensor coefficient) of the whole electromagnetic flowmeter. Please enter the standard flow when using and save it. For example, the local flow rate is 9m³/h during calibration (real-time display in the last line), and the measured standard flow rate is 10m³/h; input 10m³/h in the main screen and save it.

Flow line correction allows:

Flow linearity correction point:

Flow linear correction value:

When the flow rate linear correction is allowed, the flow rate above the flow rate linear correction point is adjusted according to the data of the flow rate linear correction value. for example:

The flow linear correction point is: 500mm/s

Flow linear correction value: -10mm

When the actual flow is greater than or equal to 500mm/s, reduce the actual flow by 10mm, and if it is 600mm/s, adjust it to 590mm/s.

Flow segment correction settings:

● Flow correction unit:

Set the flow correction point unit, select m³/h, m³/m, m³/s, kg/h, kg/m, kg/s, t/h, t/m, t/s, GPM, m/s, L/h, L/m, L/s.

- Flow correction point 1
- Standard flow 1
- Flow correction point 2
- Standard flow 2
- Flow correction point 3
- Standard flow 3
- Flow correction point 4
- Standard flow 4
- Flow correction point 5
- Standard flow

Flow segmentation correction allows:

The user chooses to allow or prohibit. The submenu in the flow correction setting can only take effect when it is allowed.

Flow correction function description

Flow correction is mainly used for linear adjustment of different flow velocity segments. This function is designed to have up to 5 corrections, which are divided into 5 flow points (or velocity points) and 5 standard flows (or standard flow rates). In practical applications, 3-segment correction, 4-segment correction, etc. can be used.

The flow segment correction is based on the original calibration coefficient. Therefore, the flow correction function should be turned off first, the sensor coefficient should be marked, and then the function should be turned on for flow correction. According to the nonlinear area of the sensor, set the correction point and standard flow. If the settings are appropriate, there is no need to re-calibrate. The setting process is as follows: first perform a preliminary calibration, and after the calibration is completed, calculate the corresponding flow rate (such as unit m³/h) and the corresponding standard flow rate (unit m/s). Then write the flow rate (or flow rate) to the correction point in the menu, and write the standard flow rate (or flow rate) to the standard flow rate in the menu. For example, in a certain calibration process, the initial calibration results are as follows:

Table 3

The calibrated flow rate(m/s)	Standard flow rate(m/s)	Error
0.95	1.0	-5%
2.05	2.0	2.5%
3.1	3.0	3.3%

The segment correction should be set as follows:

Table 4

Flow correction point 1	Standard flow 1
0.95	1.0
Flow correction point 2	Standard flow 2

2.05	2.0
Flow correction point 3	Standard flow 3
3.1	3.0
Flow correction point 4	Standard flow 4
10	10
Flow correction point 5	Standard flow 5
15	15

After the setting is complete, you can enable the flow correction permission.

Note: When setting the correction point, the following relationship should be maintained:

correction point 1 < correction point 2 < correction point 3 < correction point 4 < correction point 5

Standard flow 1 < Standard flow 2 < Standard flow 3 < Standard flow 4 < Standard flow 5

Chapter 8 Technical Parameters

8.1. Technical Parameters

Table 5 Measuring System

Execution Standard	JB/T9248-2015	
Measuring principle	Faraday's law of electromagnetic induction	
Function	Real-time flow rate, flow velocity, mass flow (when the density is constant), real-time measurement and flow accumulation	
Module configuration	Measurement system is made up of signal converter and measurement sensor	
Converter		
Compact Type	IP65	
Remote Type	IP65 for transmitter (IP65/IP68 for sensor)	
Measurement sensor		
Nominal Diameter	DN10~DN300	
Flange	In line with JB/T9248-2015 standard carbon steel (Optional stainless steel flanges), other standard flange can be customized	
Pressure rating (High pressure can be customized)	DN15 - DN250, PN \leq 1.6MPa	
	DN300, PN \leq 1.0MPa	
Lining Material	Neoprene (CR), Polyurethane (PU), PTFE (F4), PFEP (F46), PFA	
Electrode Material	316L Stainless Steel, Hastelloy C, Hastelloy B, Ti, Ta, Pt	
	Remote type	Compact type
Ingress protection	IP65 for converter, IP68 for sensor	IP65
Medium temperature	Neoprene:-10 $^{\circ}$ C ~ 70 $^{\circ}$ C	Neoprene:-10 $^{\circ}$ C~ 70 $^{\circ}$ C
	Polyurethane:-10 $^{\circ}$ C~ 60 $^{\circ}$ C	Polyurethane:-10 $^{\circ}$ C~ 60 $^{\circ}$ C
	PTFE/FEP:-10 $^{\circ}$ C~ 120 $^{\circ}$ C	PTFE/FEP:-10 $^{\circ}$ C ~ 120 $^{\circ}$ C
	PFA:-10 $^{\circ}$ C~ 180 $^{\circ}$ C	PFA:-10 $^{\circ}$ C ~ 120 $^{\circ}$ C

Table 6 Communications

Serial communications	Modbus RS-485
Output	Current (4~20 mA) , pulse , frequency
Function	Empty pipe recognition, electrode contamination, upper limit alarm, lower limit alarm

Table 7 Display User Interface

Graphic display	Monochrome LCD display with white backlight
Display function	2 measurement value pictures (measurements, condition, etc)
Language	English/Chinese
Unit	You can configure the menu to select the unit Refer to "6.4"
Operating unit	4 Mechanical keys

Table 8 Measurement Accuracy

Max measuring error	Measurement value $\pm 0.5\%$ (Flow speed $> 0.5\text{m/s}$) ; Measurement value $\pm 0.5\% \pm 2\text{mm/s}$ (Flow speed $< 0.5\text{m/s}$)
Repetitiveness	$\leq 0.16\%$

Table 9 Operating Environment

Temperature	
Environment	$-20^{\circ}\text{C} - 60^{\circ}\text{C}$
Storage	$-40^{\circ}\text{C} - 65^{\circ}\text{C}$

Table 10 Electric Conductivity

Water	Min. $20\mu\text{S/cm}$ (Actual electric conductivity should be greater than $30\mu\text{S/cm}$)
Other	Min. $5\mu\text{S/cm}$ (Actual electric conductivity should be greater than $30\mu\text{S/cm}$)

Table 11 Material

Sensor housing	Carbon steel, stainless steel 304, stainless steel 316L
Converter	Standard painted die cast aluminum

Table 12 Electrical Connections

Power supply	220VAC, 24VDC, 12VDC (Low power consumption)
Power consumption	Max 15W, minimum 3W (12VDC power supply, suitable for solar power supply occasions)
Signal cable	Apply only to remote type

Table 13 Output

Current output		
Function	Measurement of volume and quality (in the case of constant density)	
Setting	Scope	4-20mA
	Max	20mA
	Min	4mA
Passive	Corresponding terminal IV _{ee} , IO _{UT} , support 5-24VDC external power supply	
Load	250Ω, Max 1000Ω	
Pulse and frequency output		
Function	Set up Pulse and frequency output	
Pulse output	Basis	Output pulse width: 0.1ms~100ms
	Setting	0.001L~10000.000L
Frequency	Max	F _{max} ≤ 10000Hz
	Setting	0~10000Hz
Active	Turn the two red DIP switch to the ON position	
Passive	Turn the two red DIP switch to the ON position	

8.2. Electrode selection and specification

Corrosion Resistance of Electrode Material (Only for Reference)

Table 14

Material	Corrosion Resistance
Molybdenum-containing stainless steel (0Cr18Ni12Mo2Ti)	<p><u>Applicable</u>: domestic water, industrial water, sewage, weak acid-base salt solutions, normal temperature concentrated nitric acid</p> <p><u>Not applicable</u>: hydrofluoric acid, hydrochloric acid, chlorine, bromine, iodine and other media.</p>
Hastelloy B	<p><u>Applicable</u>: non-oxidizing acids, such as hydrochloric acid and hydrofluoric acid of certain concentration, alkaline solutions with a concentration of no less than 70% sodium hydroxide.</p> <p><u>Not applicable</u>: nitric acid and other oxidizing acids.</p>
Hastelloy C	<p><u>Applicable</u>: oxidizing acids, such as nitric acid, mixed acid, or sulfuric acid mixed corrosive media, corrosive environments with oxidizing salts or other oxidizing agents such as hypochlorite solution above room temperature, seawater.</p> <p><u>Not applicable</u>: reducing acids such as hydrochloric acid and chlorides.</p>
Ti	<p><u>Applicable</u>: chloride, hypochlorite, seawater, oxidizing acid.</p> <p><u>Not applicable</u>: reducing acids such as hydrochloric acid, sulfuric acid, etc.</p>
Ta	<p><u>Applicable</u>: most acids, such as concentrated hydrochloric acid, nitric acid and sulfuric acid, including hydrochloric acid with boiling point, nitric acid and sulfuric acid below 175°C.</p> <p><u>Not applicable</u>: alkalis, hydrofluoric acid, sulfur trioxide.</p>
Pt	<p><u>Applicable</u>: various acids (excluding aqua regia), alkalis and salts.</p>

8.3. Flow and Velocity Parallel Table for Electromagnetic Flowmeter

Table 15

Flow rate (m/s) Flow (m ³ /h) DN (mm)	0.1	0.2	0.4	0.5	1	10	12	15
DN10	0.0283	0.0565	0.1131	0.1414	0.2827	2.8274	3.3929	4.2411
DN15	0.0636	0.127	0.254	0.318	0.636	6.362	7.634	9.543
DN20	0.113	0.226	0.452	0.565	1.131	11.310	13.572	16.965
DN25	0.176	0.353	0.707	0.884	1.767	17.671	21.206	26.507
DN32	0.290	0.579	1.158	1.448	2.895	28.953	34.744	43.429
DN40	0.452	0.905	1.810	2.262	4.524	45.239	54.287	67.858
DN50	0.707	1.414	2.827	3.534	7.069	70.690	84.823	106.03
DN65	1.195	2.389	4.778	5.973	11.946	119.46	143.35	179.19
DN80	1.810	3.619	7.238	9.048	18.100	181.00	217.15	271.43
DN100	2.827	5.655	11.310	14.137	28.274	282.74	339.29	424.12
DN125	4.418	8.836	17.671	22.090	44.179	441.79	530.14	662.68
DN150	6.362	12.723	25.447	31.809	63.617	636.17	763.41	954.26
DN200	11.310	22.619	45.239	56.549	113.10	1131.0	1357.2	1696.5
DN250	17.671	35.343	70.686	88.357	176.71	1767.1	2110.6	2650.7
DN300	25.447	50.893	101.79	127.23	254.47	2544.7	3053.6	3817.0

8.4. Accuracy

Reference condition

- (1) Medium: water
- (2) Temperature: 20°C
- (3) Pressure: 0.1MPa
- (4) Front straight conduit: $\geq 10\text{DN}$, Rear straight conduit: $\geq 5\text{DN}$

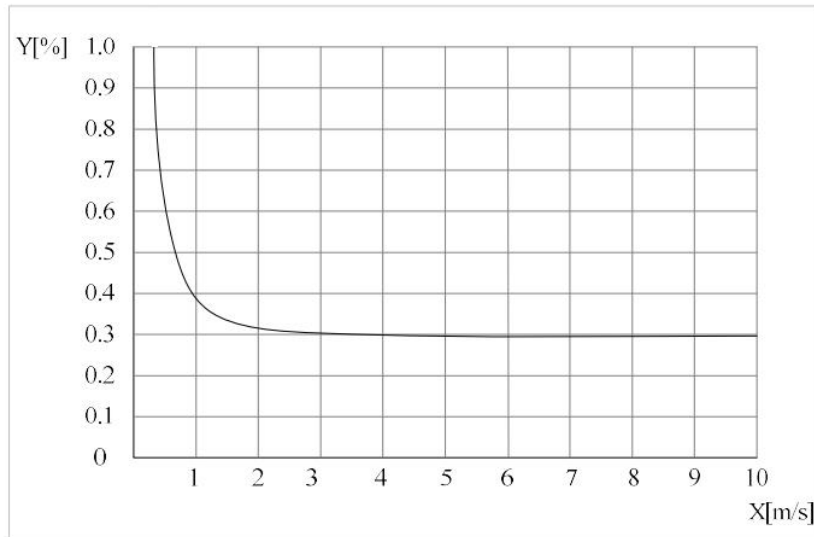

Figure 25

- ① X[m/s]: Flow rate
- ② Y[%]: Actual measured value deviation (mV)

Chapter 9 Communication

This file describes the MODBUS-RTU communication protocol of electromagnetic flowmeter.

9.1. MODBUS-RTU Protocol

The Electromagnetic flowmeter integrates the standard RS-485 interface and Modbus-RTU communication protocol.

Following is the protocol frame and data format:

The communication is asynchronous transfer mode in bytes. The data format between master and slave is 10-bit as following:

Data format	10-bit
Start bit	1 bit
Data bits	8 bits
Check bit	No
Stop bit	1 bit

Frame format:

Data format:	Address	Function	Data	CRC check
Data length:	1 byte	1 byte	N bytes	16-bit CRC(2 bytes)

9.1.1. Communication Process

Modbus protocol is a Master-Slave protocol (the flowmeter is the slave). The system has only one master node that issues explicit commands to one of the slave nodes and processes responses. Slave node will not typically transmit data without a request from the master node, and do not communicate with other slaves, and the master node initiates only one Modbus transaction at the same time. The Slave will response to the master according to the data in the frame from the master.

9.1.2. Address Field

In the Modbus protocol, the address field only contains the slave address, in this version, the address rang is 1-255. Every slave in the same system must has different slave address. A master addresses a slave by placing the slave address in

the address field of the message. When the slave returns its response, it places its own address in the response address field to let the master know which slave is responding.

9.1.3. Function Code

The function code indicates to the server what kind of action to perform. The function code can be followed

by a data field that contains request and response parameters. In this file, the electromagnetic flowmeter only uses the '03' and '10' function codes, others are reserved:

Function code	Definition	Operation
03	Read multi-register	Read one or multi-register data
10	Write multi-register	Write one or multi-register data

9.1.4. Data Filed

The data filed contains the information which information the slave needs to response. For example: flow rate, velocity, totalized value of forward flow etc. Every register in slave is 16-bit format (2 bytes), high byte in front; master can read max 50 registers one time; Some register is 4-bytes, like forward flow. Master needs to read the high 2-bytes and low 2-bytes separately (2 registers).

9.2. MODBUS Function Code Function Code "03" : Read Multi-Register

For example: Master needs to read 3 registers based from '0x000E' from the Slave addressed '0x01' :

the register in the slave is as following:

Register	Data	Variable
0x000E	0x0180	V1
0x000F	0x0180	V2
0x0010	0x0180	V3

Master will send the following frame:

	Bytes Number	Send Data	Note
Slave Address	1	0x01	Send the Slave Address
Function Code	1	0x03	Read Multi-Register
Register Start address	2	0x000E	The start register address:0x000E
Register number	2	0x0003	Read 3 registers (6 bytes)
CRC Check	2	0x6408	The CRC Check code

Slave will response:

	Bytes Number	Send Data	Note
Slave Address	1	0x01	Send the Slave Address
Function Code	1	0x03	Read Multi-Register
Bytes response	1	0x06	The data contains 6 bytes
Register 1	2	0x0180	The 0x000E register data
Register 2	2	0x0180	The 0x000F register data
Register 3	2	0x0180	The 0x0010 register data
CRC Check	2	0x215E	The CRC Check code

9.2.2. Function Code “10” : Write Multi-Register

The master can use this function code to save the date into the target registers in slave.

For example: Master needs to save ‘0x0003’ and ‘0x00FF’ into the ‘0x003A’ and ‘0x003B’ registers in the Slave

Addressed ‘0x01’ :

Master will send the following frame:

	Byte Number	Send Data	Note
Slave Address	1	0x01	Send the Slave Address
Function Code	1	0x10	Write Multi-Register

Register Start Address	2	0x003A	The Register Start Address
Register Number	2	0x0002	Register number
Data Length	1	0x04	Date Length in all registers
Register 1 Data	2	0x0003	The 0x003A register data
Register 2 Data	2	0x00FF	The 0x003B register data
CRC Check	2	0xC084	The CRC Check code

Slave will response

	Byte Number	Send Data	Note
Salve Address	1	0x01	Send the Slave Address
Function Code	1	0x10	Write Multi-Register
Register Start Address	2	0x003A	The Register Start Address
Register Number	2	0x0002	Register number
CRC Check	2	0x61C5	The CRC Check code

9.3. Data Format and Special Parameters Description

9.3.1. Data Format

Authority:

RO Read Only;

RW Readable and Writable;

Format:

DW 4-bytes integer data;

W 2-bytes integer data;

B 1-byte integer, this parameter will be added to 2-bytes with the '0x00' high byte;

SF 4-bytes single-precision floating-point format data;

Fixed Point Data: For Example: DW*1000 means the parameter is amplified 1000-fold. If the real value is 0.123, in the Modbus, the slave will response the value as 123.

Float format:

The IEEE754 format is used for the 4-bytes float data as following:

Register 1		Register 2	
BYTE1	BYTE2	BYTE3	BYTE4
S EEEEEEE	E MMMMMMM	MMMMMMMM	MMMMMMMM

9.3.2. Special Parameters Description

Flow Rate Unit(Register 24, Register 105):

- 0: L/H
- 1: L/M
- 2: L/S
- 3: M3/H
- 4: M3/M
- 5: M3/S
- 6: KG/H
- 7: KG/M
- 8: KG/S
- 9: T/H
- 10: T/M
- 11: T/S

Volume Unit(Register 25, for display setting):

- 0: 0.001L
- 1: 0.01L
- 2: 0.1L
- 3: 1L
- 4: 0.001M3
- 5: 0.01M3
- 6: 0.1M3
- 7: 1M3
- 8: 1KG
- 9: 1T

EPD: Empty Pipe Detecting

9.4. List of Modbus Registers

9.4.1. Frequently-used Registers List

Register Address	PLC address	Unit	Bytes	Authority	Format	Description
90	40091	M ³	4	RO	SF	Totalized Value of Forward flow
92	40093	M ³	4	RO	SF	Totalized Value of Reverse flow
94	40095	M ³	4	RO	SF	Flow Total Data (forward minus reverse)
96	40097		4	RW	DW	Totalizer Reset
98	40099	Refer to Register 105	4	RO	SF	Flow Rate
100	40101	m/s	4	RO	SF	Velocity
102	40103	%	4	RO	SF	Flow Ratio
104	40105	%	2	RO	W	EPD Value
105	40106		2	RO	W	Flow Rate Unit
106	40107		2	RO	W	EPD Alarm
107	40108		2	RO	W	Excitation Current Alarm

9.4.2. Full Registers ListRegister

Address	PLC address	Unit	Bytes	Authority	Format	Description
0	40001	m/s	2	R0	DW*100 0	Velocity--High bytes
1	40002		2	R0	DW*100 0	Velocity--Low bytes
2	40003	Refer to Register 24	2	R0	DW*100	Flow Rate--High bytes
3	40004		2	R0	DW*100	Flow Rate--Low bytes
4	40005	%	2	R0	B*100	Flow Ratio
5	40006	%	2	R0	B*100	EPD Value
6	40007	M ³	2	R0	DW*1	Totalized Value of Forward Flow--High bytes
7	40008		2	RO	DW*1	Totalized Value of Forward Flow--Low bytes
8	40009	M ³	2	RO	DW*1	Totalized Value of Reverse Flow--High bytes
9	40010		2	RO	DW*1	Totalized Value of Reverse Flow--Low bytes
10	40011		2	RO	DW*1	Reserved

11	40012		2	RO	DW*1	Reserved
12	40013		2	RO	B*1	System Alarm
13	40014		2	RO	B*1	Flow Direction
14	40015		2	RO	DW	Reserved
15	40016		2	RO	DW	Reserved
16	40017		2	RO	B	Reserved
17	40018		2	RO	B	Reserved
18	40019		2	RO	B	Reserved
19	40020		2	RO	B	Reserved
20	40021		2	RO	B	Reserved
21	40022	mm	2	RW	W	Pipe Diameter
22	40023		2	RW	DW	Flow Rate Range--High bytes
23	40024		2	RW	DW	Flow Rate Range--Low bytes
24	40025		2	RW	B	Flow Rate Unit
25	40026		2	RW	B	Volume Unit
26	40027	S	2	RW	W*1	Damping Period
27	40028		2	RW	W*10000	Sensor Coefficient

28	40029	HZ	2	RW	B	Excitation Frequency
29	40030	%	2	RW	B	Excitation Current
30	40031		2	RW	B	Flow Direction Setting
31	40032	mm/s	2	RW	W	Zero Drift
32	40033	%	2	RW	W*100	Flow Rate Cut-off Percent
33	40034		2	RW	B	Flow Rate Cut-off Enable
34	40035		2	RW	B	Reverse Output Enable
35	40036		2	RW	B	EPD Enable
36	40037	%	2	RW	B	EPD Alarm Threshold
37	40038		2	RW	B	Flow Rate Upper Limit Alarm Enable
38	40039	%	2	RW	W*100	Flow Rate Upper Limit Alarm Threshold
39	40040		2	RW	B*1	Flow Rate Lower Limit Alarm Enable
40	40041	%	2	RW	W*100	Flow Rate Lower Limit Alarm Threshold
41	40042		2	RW	B	Reserved

42	40043		2	RW	W*100	Reserved
43	40044		2	RW	B	Excitation Current Alarm
44	40045		2	RW	B	Pulses or Frequency Output Select
45	40046	ml	2	RW	B	Pulse Unit
46	40047	HZ	2	RW	W	Frequency Output Range
47	40048		2	RW	W	Reserved
48	40049		2	RW	B	Reserved
49	40050		2	RW	B	Reserved
50	40051		2	RW	W	Reserved
51	40052		2	RW	B	Reserved
52	40053		2	RW	B	Reserved
53	40054		2	RW	W	Reserved
54	40055		2	RW	B	Reserved
55	40056		2	RW	B	Reserved
56	40057		2	RW	W	Reserved
57	40058		2	RW	B	Reserved
58	40059		2	RW	B	Reserved

59	40060		2	RW	DW*100 00	Reserved
60	40061		2	RW	DW*100 00	Reserved
61	40062		2	RW	W	Reserved
62	40063		2	RW	W	Reserved
63	40064		2	RW	W	Reserved
64	40065		2	RW	W	Reserved
65	40066		2	RW	W*10000	Reserved
66	40067		2	RW	B	Flow Filter Enable
67	40068		2	RW	W*10000	Flow Filter Coefficient
68	40069	Min	2	RO	DW*60	Reserved
69	40070	Min	2	RO	DW*60	Reserved
70	40071		2	RW	DW	Flow Correction Point 1--High bytes
71	40072		2	RW	DW	Flow Correction Point 1--Low bytes

72	40073		2	RW	DW	Flow Correction Point 2--High bytes
73	40074		2	RW	DW	Flow Correction Point 2--Low bytes
74	40075		2	RW	DW	Flow Correction Point 3--High bytes
75	40076		2	RW	DW	Flow Correction Point 3--Low bytes
76	40077		2	RW	DW	Flow Correction Point 4--High bytes
77	40078		2	RW	DW	Flow Correction Point 4--Low bytes
78	40079		2	RW	DW	Flow Correction Point 5--High bytes
79	40080		2	RW	DW	Flow Correction Point 5--Low bytes
80	40081		2	RW	DW	Standard Flow 1--High bytes
81	40082		2	RW	DW	Standard Flow 1--Low bytes
82	40083		2	RW	DW	Standard Flow 2--High bytes

83	40084		2	RW	DW	Standard Flow 2--High bytes
84	40085		2	RW	DW	Standard Flow 3--High bytes
85	40086		2	RW	DW	Standard Flow 3--High bytes
86	40087		2	RW	DW	Standard Flow 4--High bytes
87	40088		2	RW	DW	Standard Flow 4--High bytes
88	40089		2	RW	DW	Standard Flow 5--High bytes
89	40090		2	RW	DW	Standard Flow 5--High bytes
90	40091	M ³	2	RO	SF	Totalized value of forward flow--High bytes
91	40092		2	RO	SF	Totalized value of forward flow--Low bytes
92	40093	M ³	2	RO	SF	Totalized value of reverse flow--High bytes
93	40094		2	RO	SF	Totalized value of reverse flow--Low bytes
94	40095	M ³	2	RO	SF	Flow total data--High bytes
95	40096		2	RO	SF	Flow total data-- Low bytes

96	40097		2	RW	DW	Totalizer Reset--High bytes
97	40098		2	RW	DW	Totalizer Reset--Low bytes
98	40099	Refer to Register 105	2	RO	SF	Flow Rate--High bytes
99	40100		2	RO	SF	Flow Rate--Low bytes
100	40101	m/s	2	RO	SF	Velocity--High bytes
101	40102	m/s	2	RO	SF	Velocity-- Low bytes
102	40103	%	2	RO	SF	Flow Ratio--High bytes
103	40104	%	2	RO	SF	Flow Ratio-- Low bytes
104	40105	%	2	RO	W	EPD Value
105	40106		2	RO	W	Flow Rate Unit
106	40107		2	RO	W	EPD Alarm
107	40108		2	RO	W	Excitation Current Alarm
108	40109		2	RO	W	Reserved
109	40110		2	RO	W	Reserved
110	40111		2	RO	W	Reserved

111	40112		2	RO	W	Reserved
112	40113		2	RO	W	Reserved
113	40114		2	RO	W	Protocol Version
114	40115		2	RO	W	Flow Rate Range Unit
115	40116		2	RO	W	Reserved

9.5. Modbus Communication Examples

9.5.1. How to get the totalized value of forward flow

Register Address: 90(0x5A). PLC Address: 40091

Master Send: 01 03 00 5A 00 02 E4 18

	Data Length	Send Data
Slave Address	1	01
Function Code	1	03
Register Start Address	2	00 5A
Register Length	2	00 02
CRC Check	2	E4 18

Slave Response: 01 03 04 3F C1 97 4E 49 DF

	Data Length	Send Data
Slave Address	1	01
Function Code	1	03
Data Number	4	04
Register 1 Data	2	3F C1
Register 2 Data	2	97 4E
CRC Check	2	49 DF

The totalized value of forward flow is 1.51243 m³ (3F C1 97 4E convert to SF format)

9.5.2. How to get flow rate

Register Address: 98(0x62). PLC Address: 40099

Master Send: 01 03 00 62 00 02 65 D5

	Data Length	Send Data
Slave Address	1	01
Function code	1	03
Register Start Address	2	00 62
Register Length	2	00 02
CRC Check	2	65 D5

Slave Response: 01 03 04 42 0C 00 00 2E 48

	Data Length	Send Data
Slave Address	1	01
Function Code	1	03
Data Number	4	04
Register 1 Data	2	42 0C
Register 2 Data	2	00 00
CRC code	2	2E 48

The flow rate is 35 (42 0C 00 00 convert to SF format).